

WATEROUS

Form Number F-2819
Issue Date Aug 1, 2017
Revision Date —

Slide-In CAFS Unit Gen. 2.0

Installation, Operation, and Maintenance Instructions

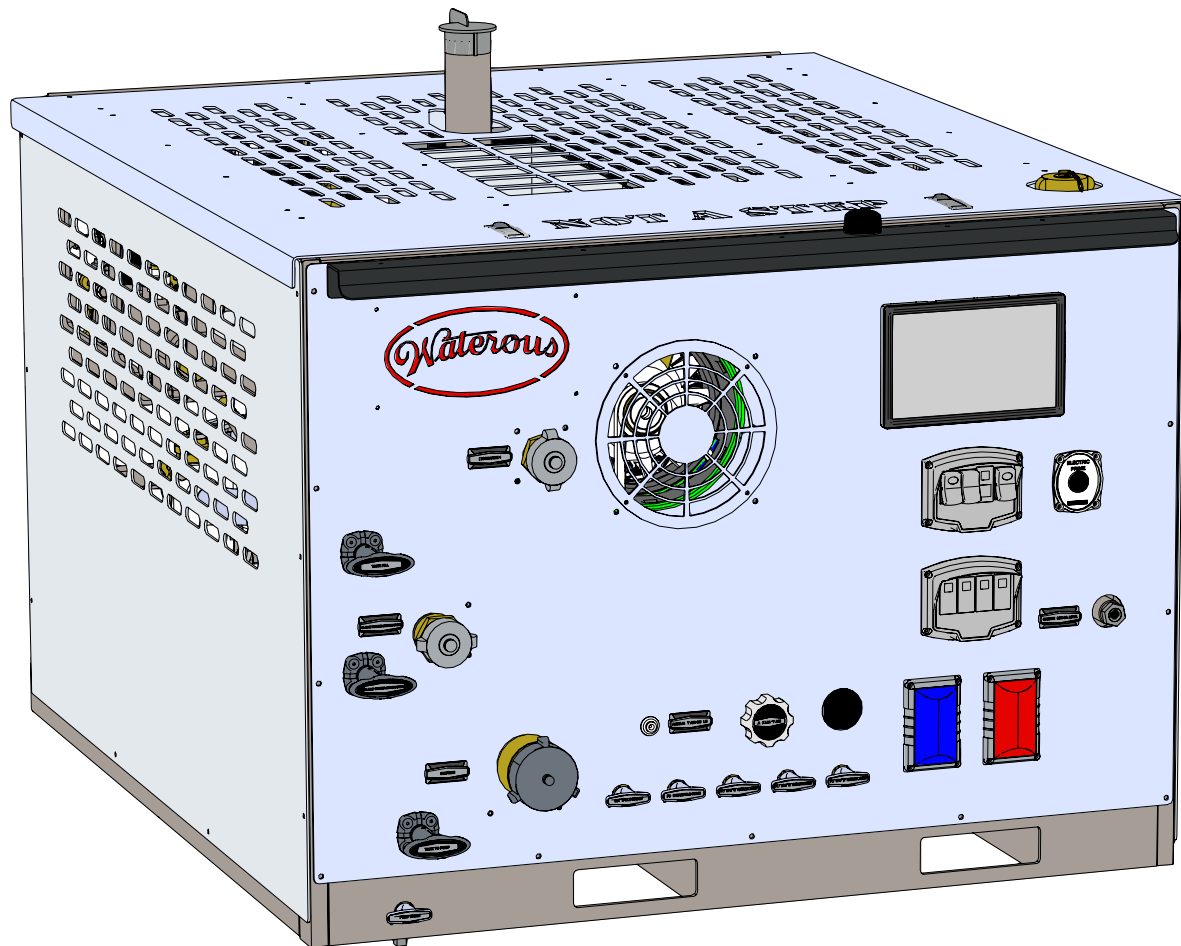

Table of Contents

Safety	5	Connecting the Fuel Supply	28
Safety Precautions	5	Filtering the Fuel	28
Safety Precautions—Continued	6	Configuring to the Fuel Lines	28
Safety Precautions—Continued	7	Choosing the Fuel Tank	28
Introduction	8	Connecting the Power Supply	29
Using this Document	8	Checking and Adding Fluids	29
Viewing the Document Electronically	8		
Printing the Document	8		
Locating the Serial Number	8		
Product Overview	9		
Operator Panel	9		
Operator Panel	10		
Outer Panels—Optional	11		
Switch Panel	12		
Warning Panel	12		
HMI Panel	13		
CAFS Screen	15		
Solution Screen	16		
Solution Screen	17		
Valve Control Screen	18		
Valve Control Screen	19		
Engine Screen—Throttle Control	20		
Engine Screen—Pressure Control	22		
Installation	24		
Dimensions	24		
Minimum Spacing for Airflow	25		
Installation overview	26		
Equipment Requirements	26		
Preparing for the Install	26		
Modifying the Equipment	26		
Locating and Drilling the Mounting Holes	27		
Installing the Module	27		
Removing the Shipping Plugs	27		
Connecting the Water Supply Tank	27		
Connecting the Tank Fill	27		
Connecting the Foam Concentrate Supply	27		
Installing the Auxiliary Air Fitting	27		
Installing the Drain Lines	27		

Continued on next page

Operation	30	Maintenance	36
Operation Overview	30	Maintenance Precautions	36
Hot Liquid	30	Maintenance Schedule	36
Hot Surface	30	Relieving Waterline Pressure	37
Operating the Panel Light	31	Relieving Airline Pressure	37
Selecting the Hose	31	Servicing the Sump	37
Selecting the Nozzle	31	Checking the Sump Oil Level	38
Understanding the Waterway Valves	31	Draining the Sump Oil	38
Tank to Pump Valve	31	Adding Sump Oil	38
Clear Water Discharge Valve	31	Replacing the Oil Separator	38
Tank fill	31	Replacing the Oil Filter	39
Operating the Waterway Valves	32	Servicing the Compressor/Pump Drive Belt	39
Opening the Valve	32	Replacing the Compressor Air Filter	40
Closing the Valve	32	Servicing the Foam Pump Oil	40
Starting and Stopping the Engine	32	Servicing the Engine Oil	40
Priming the Water Pump	32	Troubleshooting	41
Using Water Sources	32	Schematic	41
Drawing From the On-Board Tank	32	Trouble Shooting Chart	42
Drawing From an External Source	32	Warranty	44
Filling the On-board Tank	32		
Priming the Foam Pump	33		
Preparing for Operation	33		
Operating the CAFS	34		
Launching the Interface	34		
Operating the Discharge	34		
Adjusting the Solution Percent	34		
Adjusting the Valve Controls	34		
Adjusting the Engine Speed	34		
Adjusting the Water Pressure	34		
Using Discharge 1	34		
Using the Clearwater Discharge	34		
Using the Auxiliary Air Outlet	34		
Flushing the System	34		
Operating the Drain Valve	34		
Accessing the Interior Components	35		
Typical Operation Sequence	35		
Operating the Module	35		
After Operating the Module	35		

Safety Precautions

- Read and understand this document before you begin the installation.
- Read and understand all the notices and safety precautions.
- Be aware that these instructions are only guidelines and are not meant to be definitive. Contact Waterous when you have questions about installing or operating this equipment.
- Do not install this equipment if you are not familiar with the tools and skills needed to safely perform required procedures—proper installation is the responsibility of the purchaser.
- Do not operate the equipment when safety guards are removed.
- Do not modify the equipment.
- Regularly check for leaks, worn, or deteriorated parts.
- Waterous reserves the right to make modifications to the system without notice.

NOTICE

Before Operation

- Read and understand all the instructions provided.
- Check all fluid levels and replenish if necessary.
- Remove the all shipping plugs and install the operation plugs or caps.



NOTICE

Maintenance

- Not following maintenance procedures can damage your equipment.
- Perform all maintenance procedures as required.

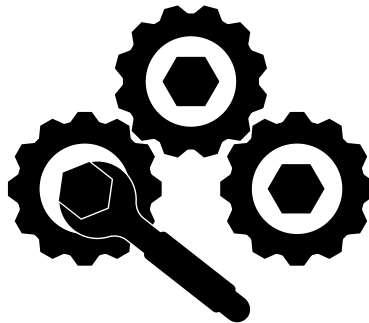

NOTICE

High Current

- High current from welding or jump start can damage electronic components.
- Disconnect all ground wire connections before jumping or welding.



Safety Precautions—Continued

NOTICE**Modification**

- Modifying the equipment can damage components and void your warranty.
- Do not modify the foam system.

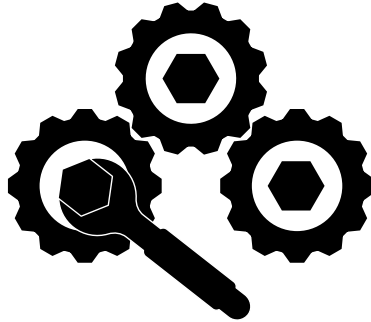
**! WARNING****Hot Liquid**

- Hot liquid can scald you.
- Do not operate if the water temperature exceeds 160°F (71°C).

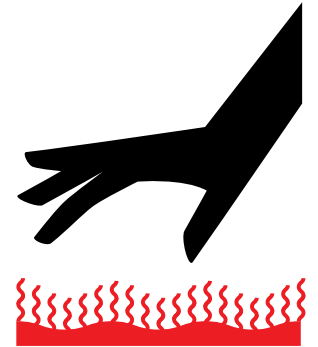
**! WARNING****Hot Surface**

- Hot surface can burn you.
- Do not touch the surface during operation—allow it to cool after operating.

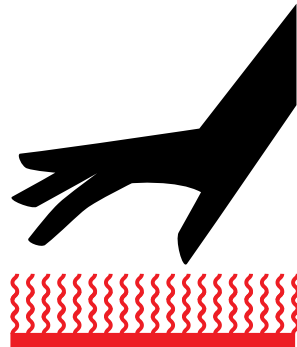
**! WARNING****High Current**

- Current can cause serious injury or death.
- Disconnect the power before servicing the pump.

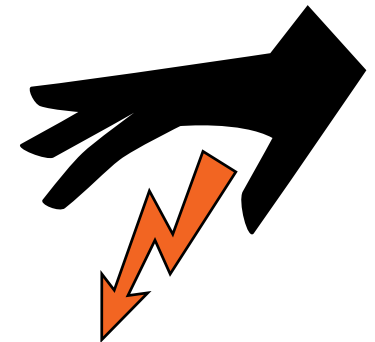

Safety Precautions—Continued

! WARNING**High Pressure**

- Liquid ejected at high pressure can cause serious injury.
- Drain the pump after use and before servicing.

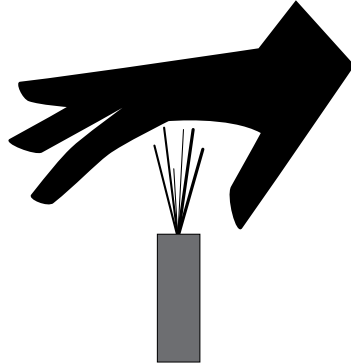
**! WARNING****Moving Parts**

- Rotating parts can cause severe injury or death
- Do not enter reach into or enter the compartment when the equipment is on.

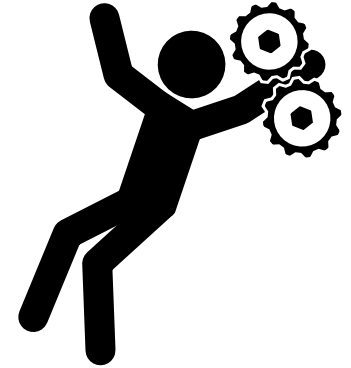
**! WARNING****High Pressure**

- Liquid ejected at high pressure can cause serious injury.
- Do not operate beyond recommended pressure.

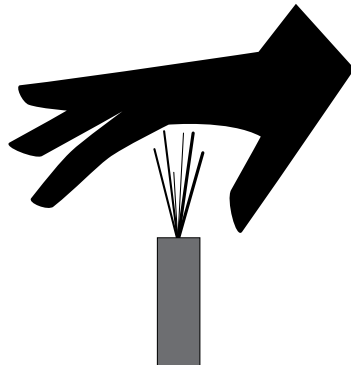

Use this document to install, operate and maintain your Waterous equipment. Please understand the following conditions before continuing with the document:

- The instructions may refer to options or equipment that you may not have purchased with your system.
- The graphics used in this document are intended to illustrate concepts. Do not use them to determine physical attributes, placement, or proportion.
- The equipment described in this document is intended to be installed by a person or persons with the necessary skills and knowledge to perform the installation.
- The equipment described in this document is intended to be operated by a person or persons with the basic knowledge of operating similar equipment.

This document is divided into the following sections:

SAFETY

This section describes general precautions and alert symbols that are in this document.

INTRODUCTION

This section is an overview of the document.

PRODUCT OVERVIEW

This section describes the components that make up the system.

INSTALLATION

This section describes the initial setup procedures.

OPERATION

This section describes how to operate the equipment.

MAINTENANCE

This section describes typical maintenance procedures.

TROUBLESHOOTING

This section provides information to troubleshooting system.

SERVICE PARTS

This section provides service part information associated with the system.

Using this Document

Use the guidelines below when viewing this document.

Viewing the Document Electronically

- View this document in landscape orientation.
- Use the table of contents to navigate directly to that section.
- Text **with this appearance** is linked to a reference.

Printing the Document

- The document is viewed the best when printed in color.
- The *print on both sides* and *flip on long edge* features can provide the best results.
- Use a 3-ring binder to store the document.

Locating the Serial Number

Locate and record the model and serial number of the equipment in your application. Have this information available when you call Waterous.

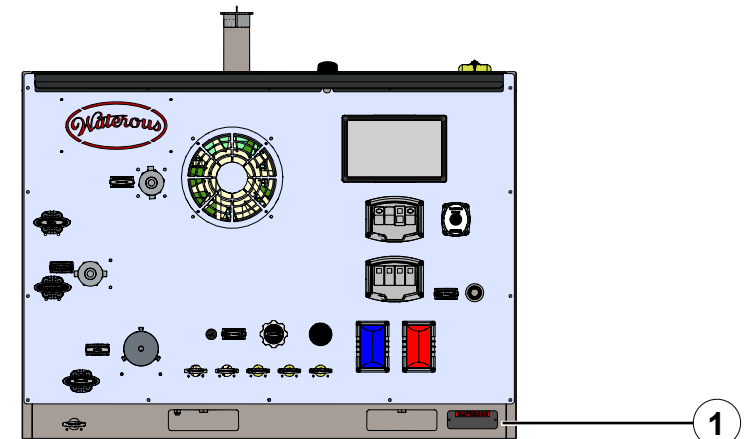

1. Serial number plate

Figure 1

Model number-

Date-

Serial number-

Operator Panel

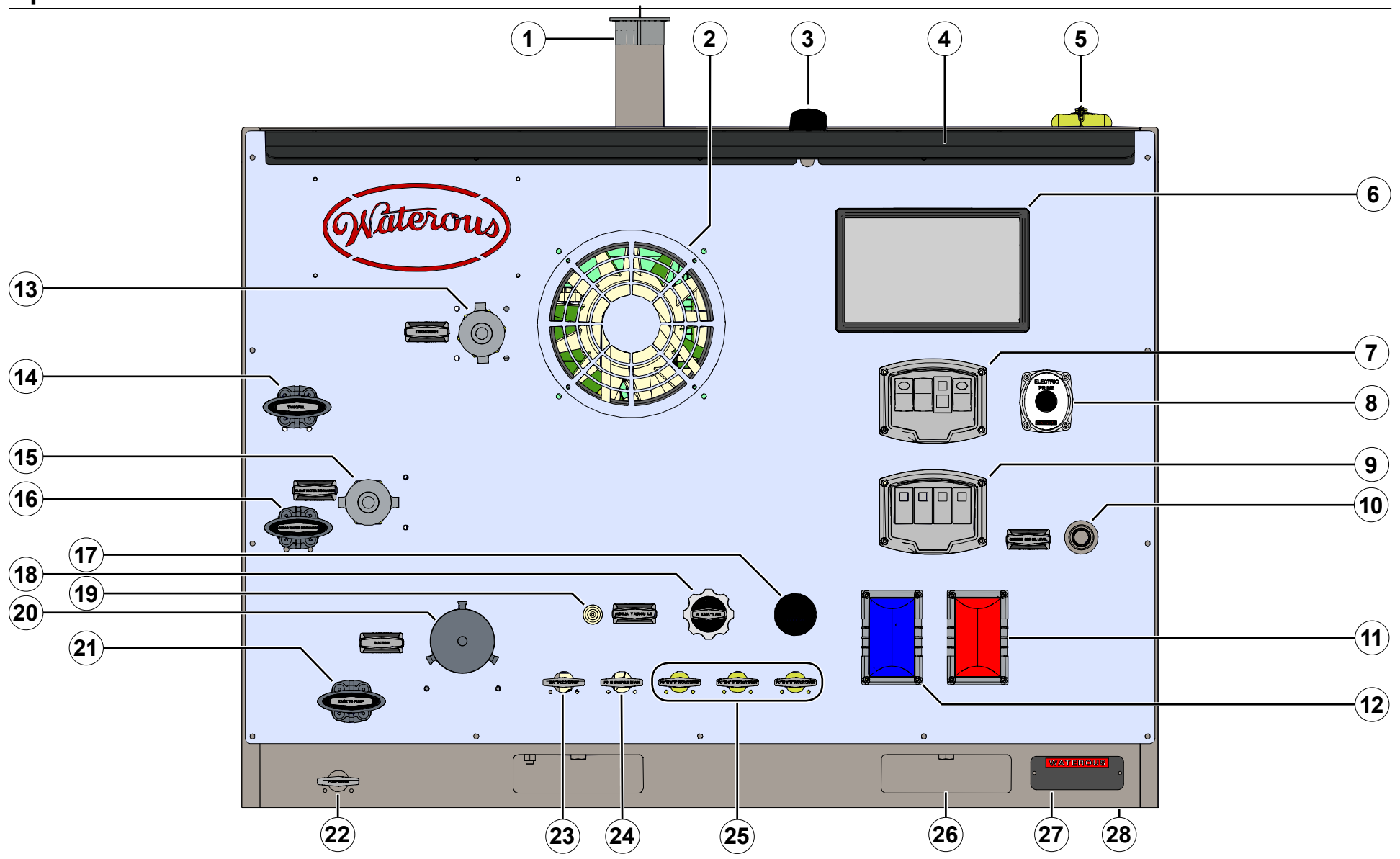

Figure 2

Operator Panel

Component	Description
1 Exhaust pipe	This routes the engine exhaust to atmosphere.
2 Air intake	This brings fresh air to the engine cooling system
3 Wireless antenna	This is the antenna for the wifi system.
4 Light panel	This light illuminates the operator panel.
5 Compressor oil fill cap	This allows you to add oil to the cooler reserve.
6 HMI (human machine interface)	The HMI displays information about the equipment during operation.
7 Switch panel	This panel holds the startup controls and panel light switch.
8 Electric prime button	This button initiates the pump priming process.
9 Warning panel	This panel holds the warning lights.
10 Compressor oil level window	This displays the compressor oil level.
11 Foam level LED	This displays the foam supply level.
12 Water tank level LED	This displays the water supply level.
13 Discharge 1 discharge	This is the panel mounted foam solution discharge and hose connection.
14 Tank fill valve handle	This opens and closes the valve that flows water to the tank. It recirculates the tank water or fills the tank.
15 Clear water discharge	This is the panel mounted clear water discharge and hose connection.
16 Clear water discharge valve handle	This opens and closes the valve that flows water to the clear water discharge outlet.
17 Hour meter	This measures the equipment run time.
18 Auxiliary air valve	This controls the auxiliary air outlet.
19 Auxiliary air outlet	This port provides an outlet for compressed air.
20 Suction intake	This is an intake for externally sourced water supply.
21 Tank to pump valve handle	This opens and closes the valve to flow water from the on-board tank.
22 Pump drain valve handle	This operates the valve that drains the water pump.
23 Manifold drain handle	This operates the valve that drains the manifold.
24 Foam manifold drain handle	This operates the valve that drains the foam manifold.
25 Foam generator drain handles	This operates the valve that drains the foam generator.
26 Fork lift opening	This allows a forklift to transport the equipment.
27 Serial plate	This is where the serial number is located.
28 Hold down tab	This mounts the equipment to the apparatus.

Outer Panels—Optional

Note: The side panels are optional equipment and are not used in every application.

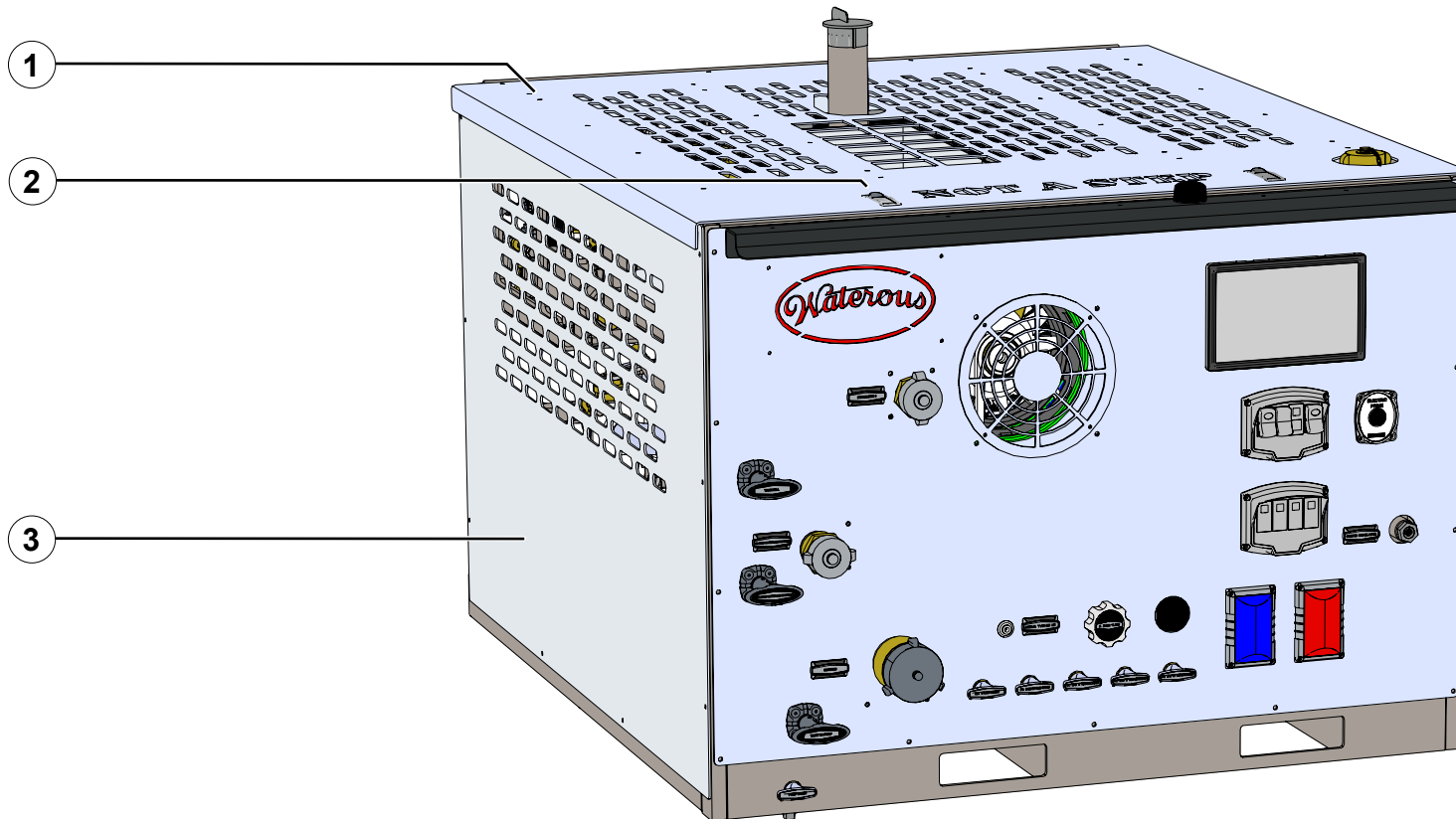

Figure 3

Feature	Description
1 Top panel	This panel covers the top of the equipment.
2 Top panel latch	This secures the panel to the frame.
3 Side panels	This panels cover the side of the equipment.

Switch Panel

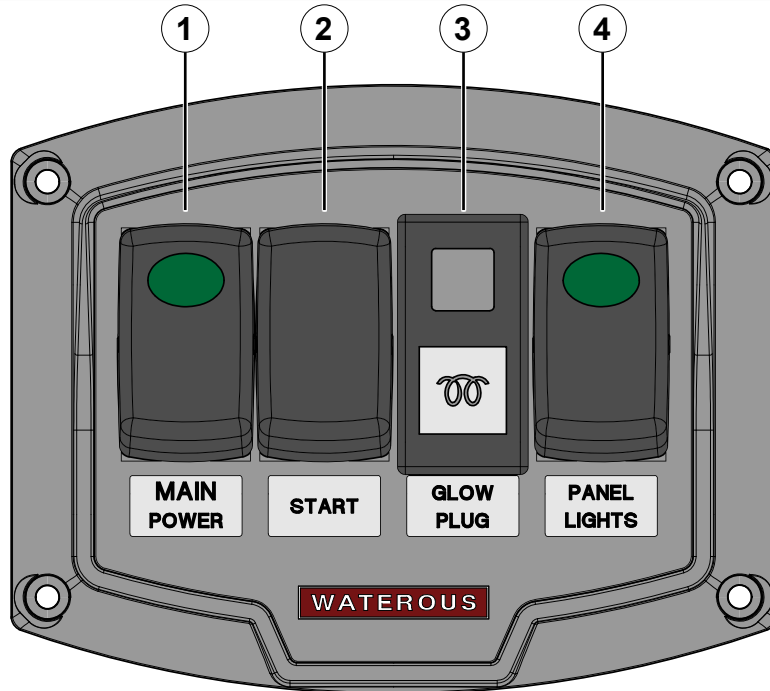

Figure 4

Button	Description
1	Main power This enables the main power circuit.
2	Start This starts the engine.
3	Glow plug This indicates when the glow plug is operating.
4	Panel lights This enables the panel lights.

Warning Panel

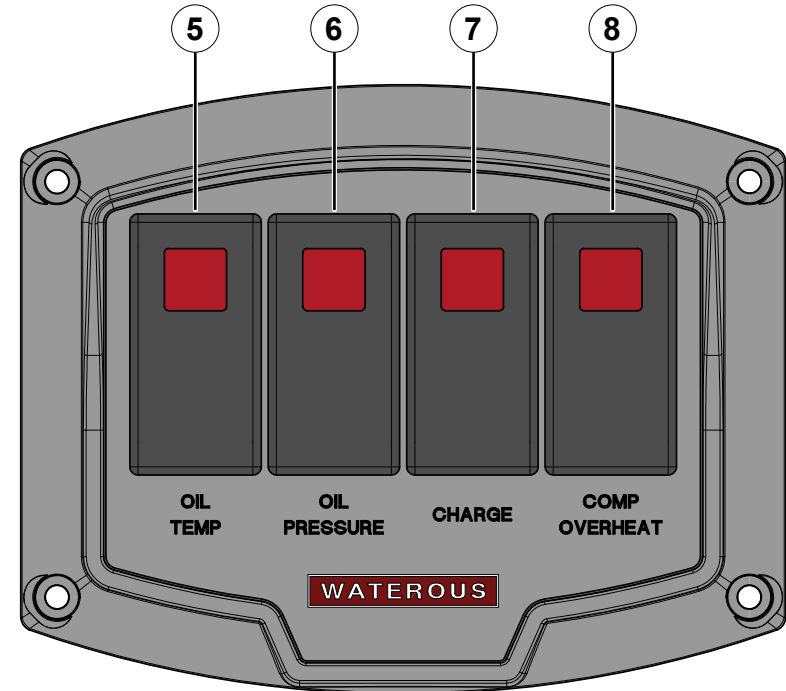

Figure 5

Indicator	Description
5	Oil temp This illuminates when the engine oil is above operating temperature.
6	Oil pressure This illuminates when the engine oil is above or below operating pressure.
7	Charge warning This illuminates when the alternator is charging the battery.
8	Comp overheat This indicates the compressor is above operating temperature—Not used in all application.

HMI Panel



Figure 6

Feature	Description
1 Panel bezel	This contains the display and operating software.
2 Optical reset button	This resets the HMI.
3 Operating system version	This indicates the firmware version.
4 Splash screen	This is the opening screen and indicates the system is initiated.
5 CAFS application version	This indicates the software version.

CAFS Screen

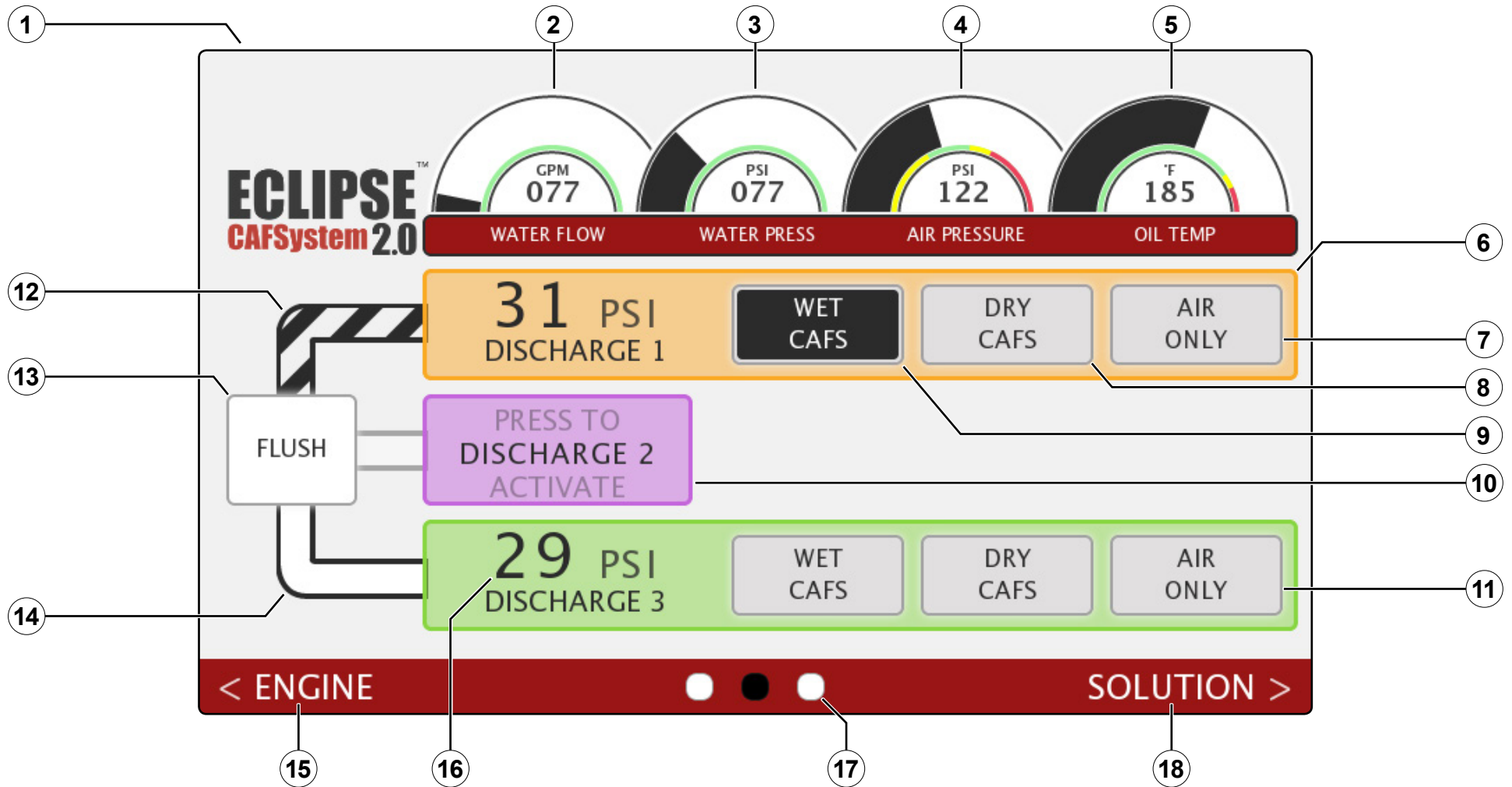

Figure 7

CAFS Screen

Use the CAFS screen to control the compressed air foam system (CAFS). You can enable and disable the discharge, determine the output for each discharge, and flush the discharge after use. Each discharge operates independently from the others. That allows one discharge to output wet CAFS, dry CAFS in another, while outputting compressed air (where regulations permit) in another output.

Feature	Description
1 CAFS screen	This allows you to control the CAFS output.
2 Water flow gauge	This shows the volume of water currently flowing.
3 Water pressure gauge	This shows the current water pressure.
4 Air pressure gauge	This shows the current air pressure.
5 Oil temperature gauge	This shows the compressor oil temperature.
6 Discharge menu—active state	This shows the menu bar is active and presents the output for the discharge.
7 Air only button	This option outputs air through the discharge—double tap to activate. Suitable for blowing out hose lines. Available where regulations permit.
8 Dry CAFS button	This option outputs dry CAFS through the discharge.
9 Wet CAFS button	This option outputs wet CAFS through the discharge.
10 Discharge Button—disabled state	This enables and disables the discharge. The disabled state is shown.
11 Discharge menu—available, but not active	This shows the discharge in an enabled state. Pressing the output option activates the discharge.
12 Discharge indicator—activity	This indicates that foam is flowing, or flowed through the discharge. Active=animated. Inactive=transparent
13 Flush button	This allows you to flush the discharge—double tap to activate.
14 Discharge indicator—inactivity	This indicates that no foam has flowed through the discharge.
15 Navigation button—go to engine screen	This button navigates you to the engine screen.
16 Discharge pressure indicated	This shows the discharge pressure.
17 Screen navigation indicator	This indicates your location in the menu screens.
18 Navigation button—go to solution screen	This button navigates you to the solution screen.

Solution Screen

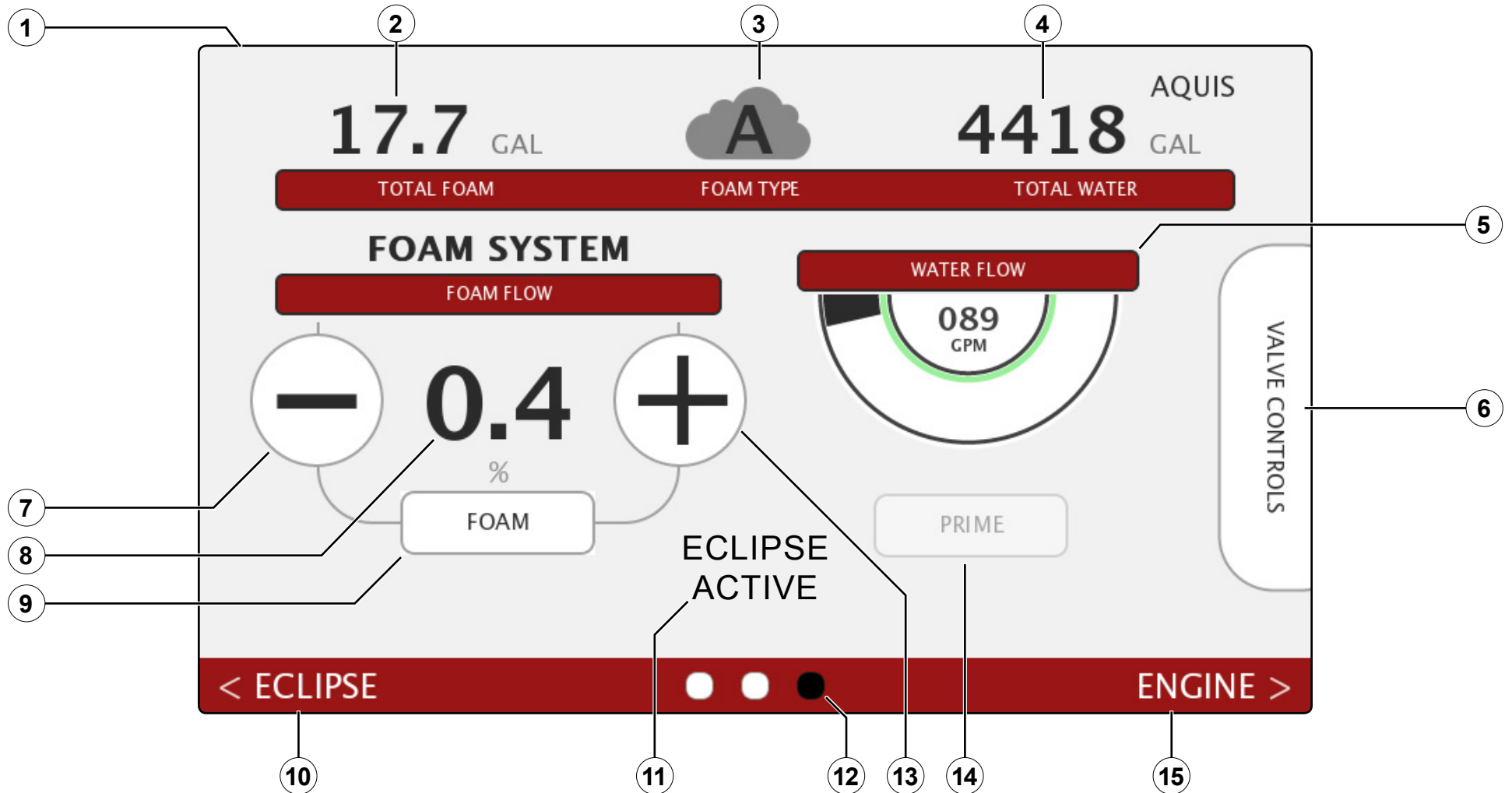

Figure 8

Solution Screen

Use the solution screen to adjust the foam solution parameters. Adjust the concentration percent to develop the foam characteristic desired.

Feature	Description
1 Solution screen	This allows you to adjust the foam parameters.
2 Total foam flowed	This shows the total amount of foam produced during the current operation.
3 Foam type and status	This shows the foam type and system status. Active=animated. Inactive=static
4 Total water flowed	This shows the total amount of water flowed during the current operation.
5 Water flow gauge	This shows the volume of water currently flowing.
6 Valve controls button	This button navigates you to the valve control screen.
7 Minus (-) button	This button decreases the value.
8 Foam concentrate percent	This shows the percent of concentrate injected into the water flow.
9 Foam button	This button enables and disables the foam system
10 Navigation button—go to eclipse screen	This button navigates you to the eclipse screen.
11 Foam system active	This appears when the foam system is active.
12 Screen navigation indicator	This indicates your location in the menu screens.
13 Plus (+) button	This button increases the value.
14 Prime button	This button primes the foam pump with foam concentrate.
15 Navigation button—go to engine screen	This button navigates you to the engine screen.

Valve Control Screen

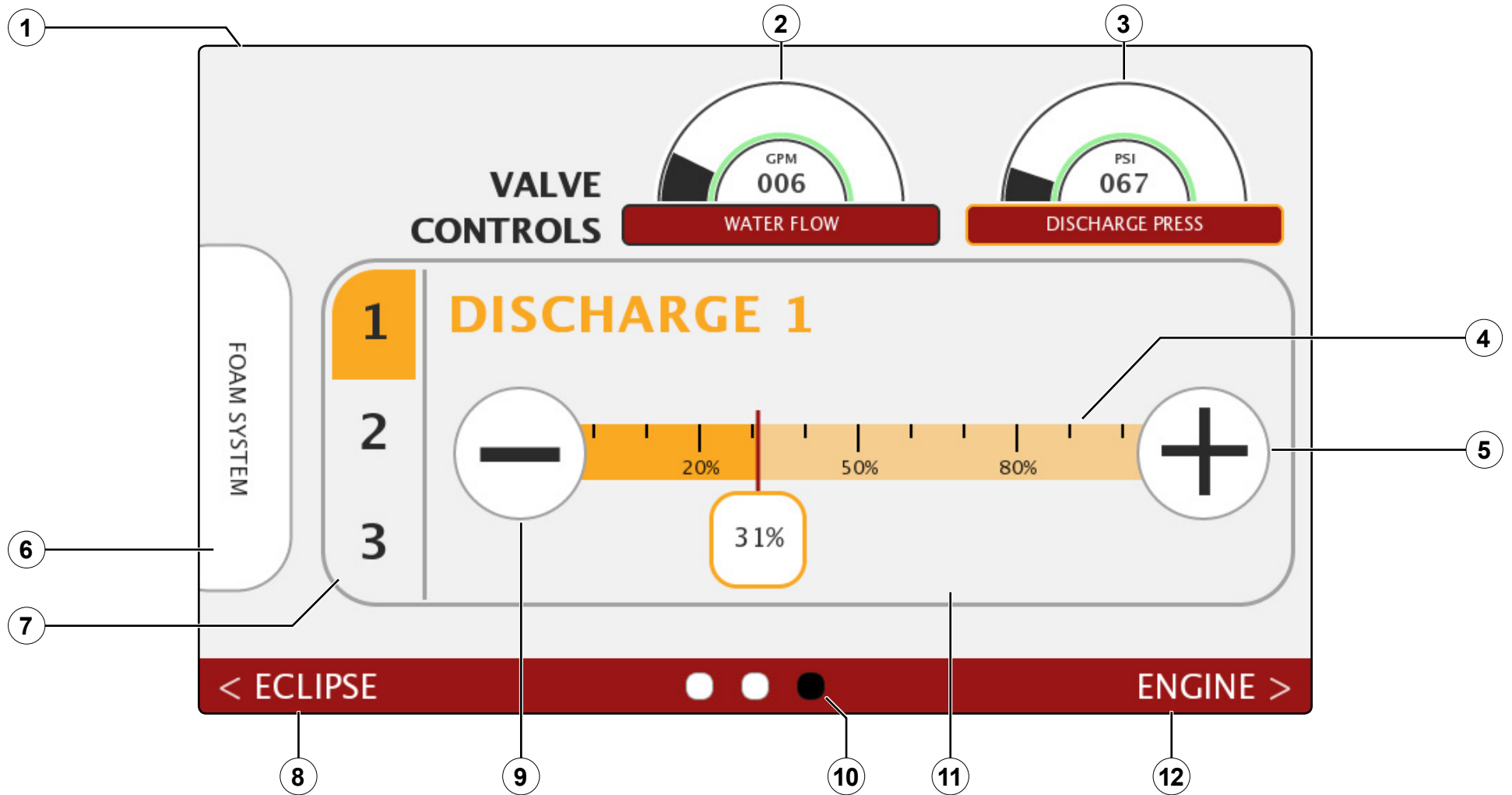

Figure 9

Valve Control Screen

Use the valve control screen to adjust the valve parameters.

Feature	Description
1 Valve control screen	This allows you to adjust the valve parameters.
2 Total water flowed	This shows the current water flow.
3 Discharge pressure	This shows the current discharge pressure.
4 Percent scale	This shows the setting valve from 0 to 100%.
5 Plus (+) button	This button increases the value.
6 Foam system button	This button navigates you to the foam system screen.
7 Discharge selection	The menu allows you to select the discharge.
8 Navigation button—go to eclipse screen	This button navigates you to the eclipse screen.
9 Minus (–) button	This button decreases the value.
10 Screen navigation indicator	This indicates your location in the menu screens.
11 Value indicator	This shows the selected value.
12 Navigation button—go to engine screen	This button navigates you to the engine screen.

Engine Screen—Throttle Control

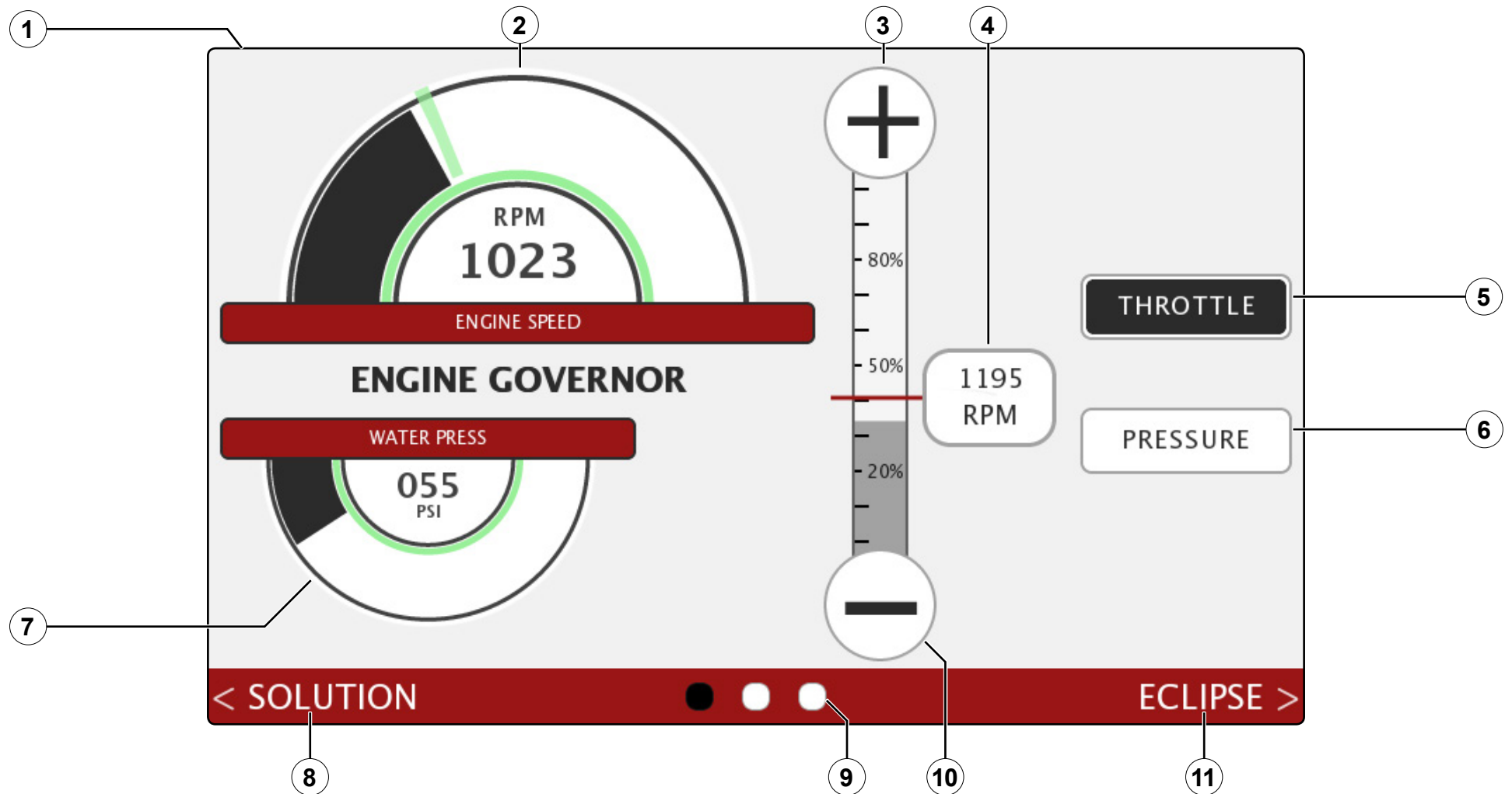

Figure 10

Engine Screen—Throttle Control

Use the engine screen to adjust the engine speed.

Feature	Description
1 Engine screen	This allows you to adjust the engine speed.
2 Engine speed gauge	This shows the current engine speed.
3 Plus (+) button	This button increases the value.
4 Value indicator	This shows the selected value.
5 Throttle button	This button navigates to the throttle screen.
6 Pressure button	This button navigates to the pressure screen.
7 Water pressure	This shows the current water pressure.
8 Navigation button—go to solution screen	This button navigates you to the solution screen.
9 Screen navigation indicator	This indicates your location in the menu screens.
10 Minus (–) button	This button decreases the value.
11 Navigation button—go to eclipse screen	This button navigates you to the eclipse screen.

Engine Screen—Pressure Control

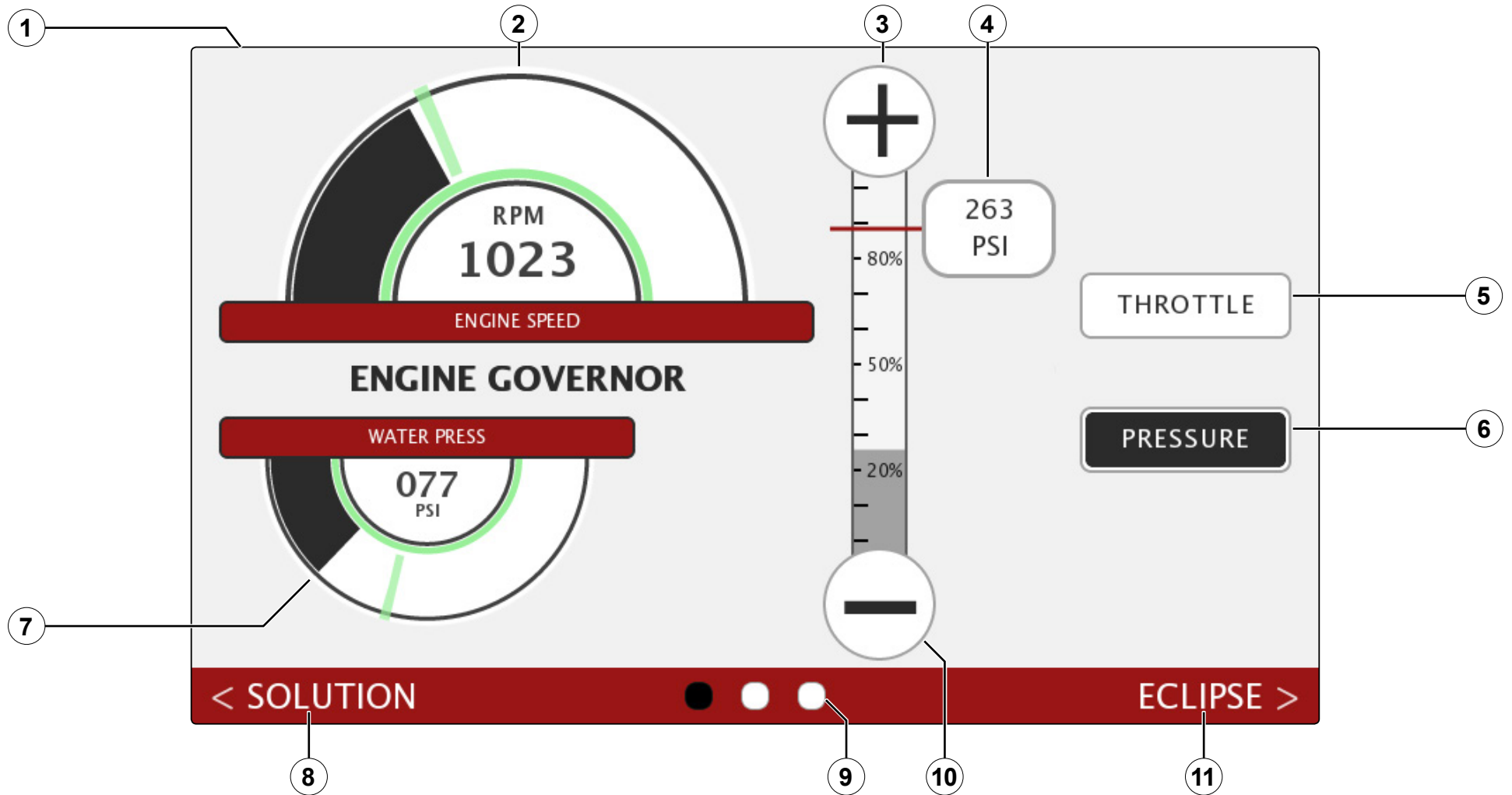

Figure 11

Engine Screen—Pressure Control

Use the pressure control screen to adjust the valve parameters.

Feature	Description
1 Pressure control screen	This allows you to adjust the pressure.
2 Engine speed gauge	This shows the current engine speed.
3 Plus (+) button	This button increases the value.
4 Value indicator	This shows the selected value.
5 Throttle button	This button navigates to the throttle screen.
6 Pressure button	This button navigates to the pressure screen.
7 Water pressure	This shows the current water pressure.
8 Navigation button—go to solution screen	This button navigates you to the solution screen.
9 Screen navigation indicator	This indicates your location in the menu screens.
10 Minus (–) button	This button decreases the value.
11 Navigation button—go to eclipse screen	This button navigates you to the eclipse screen.

Dimensions

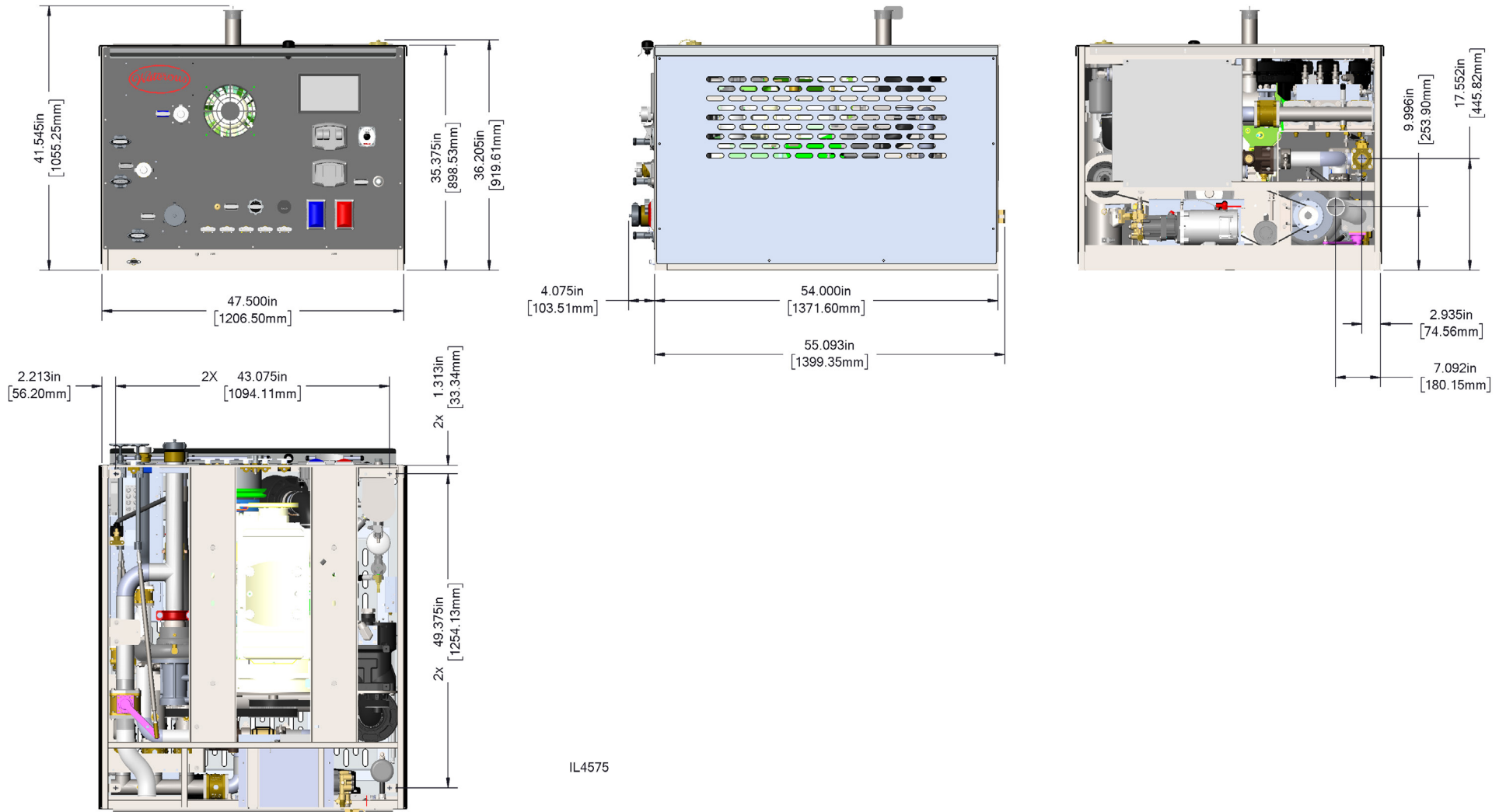

Figure 12

Minimum Spacing for Airflow

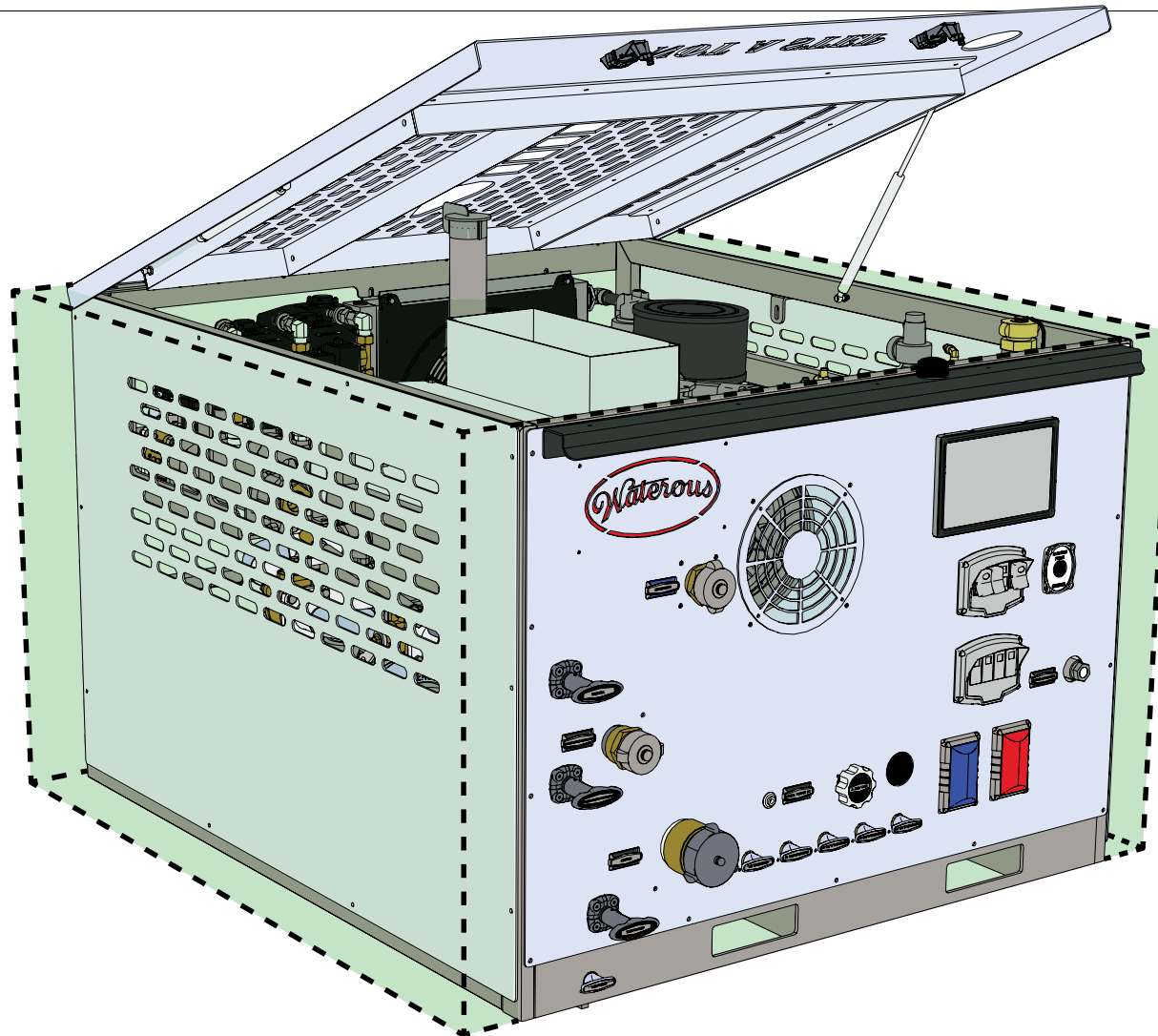

Figure 13

Important: It is preferred that a minimum of 3 inches (75 mm) of space is provided around the sides and back of the module for airflow. If this is not possible, it may be necessary to drill ventilation holes in the apparatus. Not providing suitable airflow will void your warranty. Never place anything on the top panel.

Installation overview

The slide-in module consists of an engine, compressor, foam pump, fire pump, and control panel, mounted on a steel frame. They are designed to slide into commercially available vehicles. You can add a water tank to make an all in one system. Otherwise, the equipment can draw from external water source.

This equipment system is intended to be installed by a person or persons with the basic knowledge of installing similar equipment. Contact Waterous with questions about installing the equipment. The installation, in-part, requires the following tasks and abilities:

- Lifting the equipment into a vehicle
- Locating, drilling, and cutting features into the vehicle
- Connecting the fuel supply and return to the motor
- Connecting power to the equipment
- Checking, adding or filling fluids
- Final testing

Equipment Requirements

- The engine requires fresh air suitable for combustion and cooling. Do not enclose the equipment within the apparatus without providing adequate ventilation for heat buildup and suitable fresh air intake. Not providing adequate ventilation and suitable fresh air intake will cause premature equipment failure and void your warranty. Contact Waterous for more information.
- The system requires 12 Vdc and a frame ground to operate. Make sure that you provide suitable electrical cables to power your application. Contact Waterous for more information.
 - Note:** Some modules use 24 Vdc.
- The system requires a fuel lift pump and hoses suitable for your application. Contact Waterous for more information.

Preparing for the Install

Read and understand the install instructions before installing the equipment—Contact Waterous with questions about installing the equipment. Make sure that you do the following before you install the equipment:

- Prepare a suitable, well lite, area, and gather all the necessary tools before you install the equipment:
- Make sure that the forklift is rated to lift the equipment.
- Make sure that the vehicle is rated to operate with the equipment and supply tanks used in your application.
- Ensure that you provide adequate ventilation.

Modifying the Equipment

This equipment is intended to operate as designed. Do not remove, modify, or change the components in the system. Doing so will void the warranty. Contact Waterous for more information.

NOTICE

Modification

- **Modifying the equipment can damage components and void your warranty.**
- **Do not modify the foam system.**

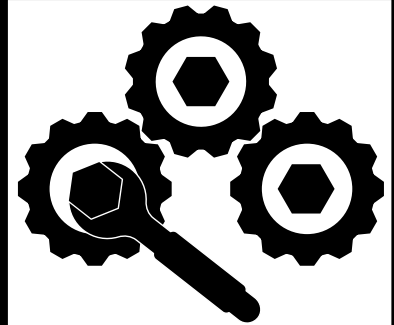

Do not modify the system or any components. Doing so will void your warranty.

Locating and Drilling the Mounting Holes

Determine a location that allows you to secure the system to the apparatus. Use the appropriate hardware for your specific application. Contact Waterous for more information.

1. Use the dimensions in **Figure 12** to locate the mounting holes.
2. Drill the mounting holes.

Note: Be aware when you drill through the mounting surface. Do not drill into items behind the mounting surface.

Installing the Module

1. Use a fork lift and fork lift openings to position the system into the install location (**Figure 2**).

Note: Make sure that you do not shear the bolts in the channel.

2. Align the hold down tabs over the mounting holes.
3. Route the drain hoses.
4. Use the appropriate hardware to secure the system to the apparatus.

Removing the Shipping Plugs

Remove the shipping plugs as you install that portion of the module.

Connecting the Water Supply Tank

1. Locate the water supply intake at the rear of the module (**Figure 14**).

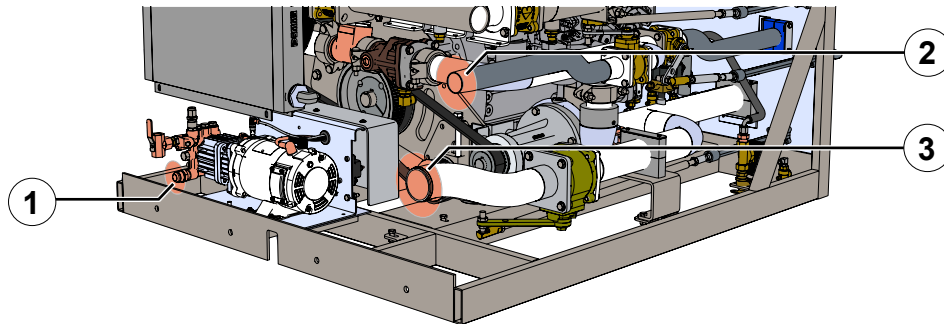

1. Concentrate input

2. Tank fill

3. Water supply intake

Figure 14

3. Connect the supply hose to the supply inlet (**Figure 14**).

Connecting the Tank Fill

1. Connect a hose to the tank fill outlet (**Figure 14**).
2. Route and connect the hose to the supply tank inlet.

Connecting the Foam Concentrate Supply

1. Route a hose from the concentrate supply tank to the concentrate input on the foam pump (**Figure 14**).
2. Refer to the *AQUIS™ Foam System* manual for supply hose installation details and requirements.

Installing the Auxiliary Air Fitting

1. Determine the required fitting for your application.
2. Wrap plumbing tape or apply sealant to the threads on the fitting.
3. Install the fitting to the auxiliary air port (**Figure 2**).

Installing the Drain Lines

The drain hoses for the engine and compressor oil are coiled and stored in the module for shipping. However, hoses for the water and foam drain lines are supplied by the apparatus manufacturer.

1. Install and route a hose to each drain valve to the discharge location on the apparatus.
2. Use cable ties to secure the hose to the apparatus.

Note: Make sure that the hose does not contact hot, abrasive, or sharp parts.

2. Route a supply hose from the supply tank to the supply inlet.

Connecting the Fuel Supply

The fuel tank configuration is determined by your application. The fuel can be supplied by a dedicated fuel tank or a fuel tank that supplies the apparatus. Use the information from this section and the *Engine Manual* to configure your application.

Filtering the Fuel

- Connect the fuel line to the fuel filter on the engine. Refer to the engine manufacturer instructions.
- Additional strainers and fuel filters is required when poor quality fuel is used.
- An additional water separation filter is required if your fuel supply contains or conditions cause it to contain high water content.

Configuring to the Fuel Lines

Use the table to determine the minimum cross section of the fuel line.

Fuel Line Length	Minimum Cross Section
Less than 6 ft (2 m)	3/8 inch (10 mm)
6 ft (2 m) – 18 ft (6 m)	1/2 inch (12 mm)

Use the **Figure 15** to configure the supply and return lines when connecting to a dedicated fuel tank.

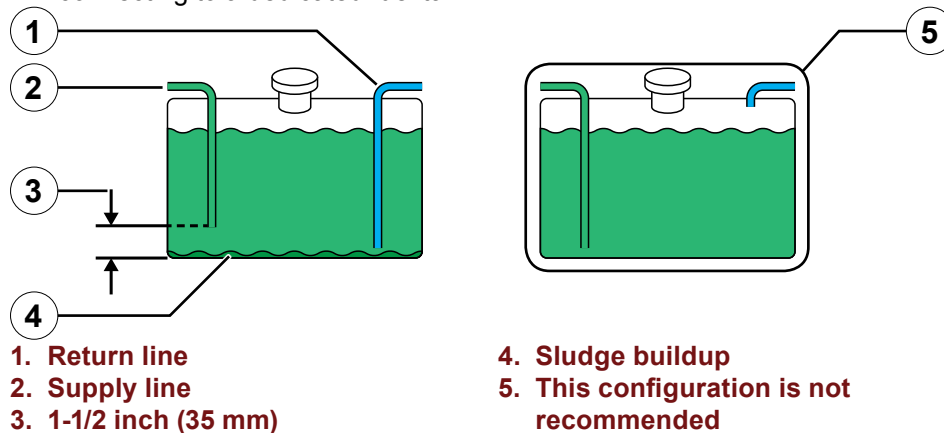

Figure 15

- Set the supply line 1-1/2 from the tank bottom for sludge buildup.

Use **Figure 16** to configure the supply and return lines when connecting to the apparatus fuel tank.

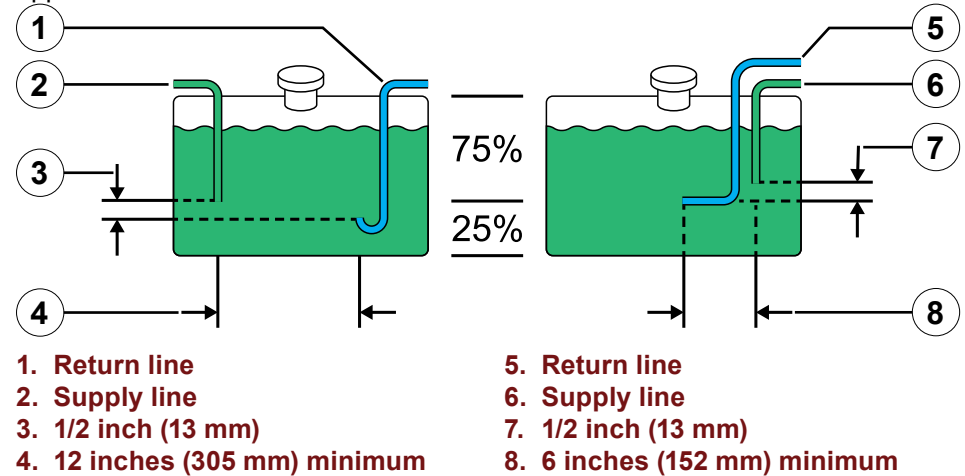

Figure 16

- Do not allow the module to draw fuel below 75% of the fuel tank capacity. This is required by NFPA standards to ensure that there is fuel remaining to move the apparatus.
- Set the return line 1/2 inch (13 mm) below the supply line.
- Non-metal lines must withstand operating at 212 °F (100 °C).
- Route the lines as straight and as short as possible.
- Make sure that the line doesn't kink.

Choosing the Fuel Tank

- The fuel tank must vent at any operating angle.
- The tank cannot be made with or contain a high level of zinc.
- The tank must allow sludge to drain.
- The fuel intake cannot be lower than 78 inches (2 m) from engine fuel pump.

Connecting the Power Supply

Use a minimum of a 2 gauge wire and a supply capable of 900 peak amps to power the module.

! **WARNING**

High Current

- Current can cause serious injury or death.
- Disconnect the power before servicing the pump.

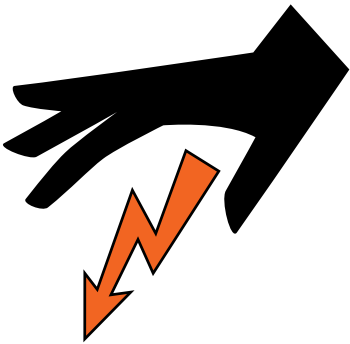

Read and understand the following statements before continuing:

- The module uses and generates high current during operation.
- Electrical current is dangerous and can cause serious injury or death.
- Do not attempt to connect the module to the power source if you have not been trained and understand the safety practices needed to install devices requiring high current.

1. Locate the terminal posts on the compressor side of the module (**Figure 17**).

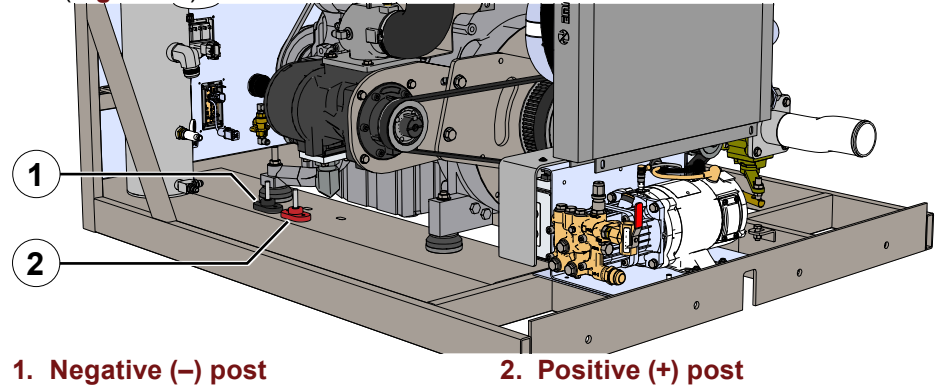

Figure 17

1. Negative (-) post

2. Positive (+) post

Note: Make sure that the positive (+) and negative (-) cables are equal length.

2. Connect the positive (+) cable from the power supply to the positive (+) post.
3. Connect the negative (-) cable from the negative (-) post to chassis ground.

Note: Make sure that the module ground is connected to the chassis ground and the chassis is connected to the negative (-) battery post.

4. Use cable ties to secure the cables.

Note: Make sure that you do not secure the cables to hot, abrasive, or sharp parts.

Checking and Adding Fluids

The oil is drained from the motor and sump before shipping. Add oil before you operate the equipment.

1. Add oil to the engine; refer to the engine *Operator's Manual*.
2. Add oil to the sump; refer to "**Adding Sump Oil**" on page 38.
3. Check the oil in the foam pump; refer to the foam pump *Operator's Manual*.

Operation Overview



The system can operate in several pumping modes; water only, water with foam solution only, water with foam solution and compressed air, and (where regulations permit) compressed air only.

Hot Liquid

Certain operating conditions will cause the solution temperature to reach and exceed 160 °F (71 °C).

Hot Surface

Components in the system become hot during operation. Allow components to cool after operation. Do not place equipment on the module cover.

 WARNING	
<h3 style="text-align: center;">Hot Liquid</h3> <ul style="list-style-type: none"> • Hot liquid can scald you. • Do not operate if the water temperature exceeds 160°F (71°C). 	

Avoid conditions that result in high temperature solution. Do not operate when solution temperature exceeds 160 °F (71 °C).

 WARNING	
<h3 style="text-align: center;">Hot Surface</h3> <ul style="list-style-type: none"> • Hot surface can burn you. • Do not touch the surface during operation—allow it to cool after operating. 	

Do not touch the hot components and allow components to cool before handling. Never place anything on the top panel.

! WARNING

High Pressure

- Liquid ejected at high pressure can cause serious injury.
- Do not operate beyond recommended pressure.

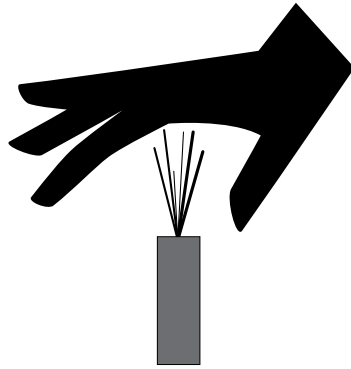

Do not operate while all discharges or drains are closed. High pressure will result and damage to the system, its components or high pressure leaks could occur.

! WARNING

Moving Parts

- Rotating parts can cause severe injury or death
- Do not enter reach into or enter the compartment when the equipment is on.

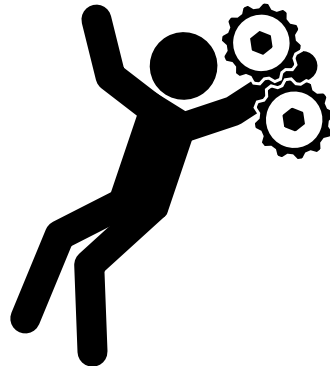

Rotating parts when the equipment is operating. Do not enter or reach into the module while the equipment is running.

Operating the Panel Light

Press the panel light button to turn the panel lights on and off (**Figure 4**).

Selecting the Hose

Select a hose rated for CAFS use for best performance.

Selecting the Nozzle

You can use a variety of nozzle types and sizes to discharge compressed air foam. Consider the following when selecting the nozzle:

- Smooth bore nozzles provide best foam performance.
- Smaller diameter nozzle tip produce a wetter foam and larger diameter nozzle tip produce a dryer foam.
- Fog nozzles tend to break down the foam structure making a wetter less expansive foam.

Understanding the Waterway Valves

Use the valves to manage the water flow in the system. The valves perform the following functions:

Tank to Pump Valve

- Controls whether the water source is the on-board tank or the suction intake on the operator panel.
- Always operate the valve fully open or fully closed.

Clear Water Discharge Valve

- Controls whether the water flows to the clear water outlet on the operator panel.
- It is possible to operate the CAFS and clear water discharge given an adequate water supply is flowing through the pump.

Tank fill

- Allows water to flow from the suction in-take to fill the on-board tank.
- Allows water to recirculate to prevent the pump from overheating.

Operating the Waterway Valves

The waterway valve handles are mechanically linked to the valve. The valve can be opened partially and locked.

Note: *Keep the valves pushed in and closed when not operating the equipment. In some wild-land applications, the valves operate in reverse.*

Opening the Valve

The valve is completely open when fully pulled out.

1. Pull the handle out to open the valve.
2. Turn the handle 90° vertical to lock the handle into position.

Closing the Valve

The valve is closed when fully pushed in.

1. Turn the handle 90° horizontal to unlock the handle.
2. Push the handle in to close the valve.

Starting and Stopping the Engine

1. Press the main power button to turn on the power (**Figure 4**). The button illuminates to indicate that it is on.
2. Press and hold the start button until the engine starts.

Note: *Wait for the glow plug indicator to turn off before starting the engine.*

3. Press the main power button to stop the engine and shut off the system.

Priming the Water Pump

Priming the pump is only required when sourcing water from an external source such as an open body of water, a fire hydrant, or when filling the water supply tank on the apparatus.

1. Start the engine. Refer to: **"Starting and Stopping the Engine" on page 32**.
2. Press and hold the prime pump button until water fills the fire pump and adequate pressure builds up.
3. Begin operating the system.

Using Water Sources

The system can draw water from a tank on the apparatus or from an external source, such as a fire hydrant. The following instruction describe how to adjust the equipment for each application.

Drawing From the On-Board Tank

1. Fully open the tank to pump valve.
2. Partially open the tank fill valve.
3. Close the clear water discharge valve.
4. Start the engine. Refer to: **"Starting and Stopping the Engine" on page 32**.
5. Begin operating the system.

Drawing From an External Source

1. Close the tank to pump valve (**Figure 2**).
2. Close the tank fill valve.
3. Close the clear water discharge valve.
4. Connect a hose from the source to the suction intake.
5. Start the engine. Refer to: **"Starting and Stopping the Engine" on page 32**.
6. Press and hold the prime pump button until water fills the fire pump and adequate pressure builds up.
7. Begin operating the CAFS.

Filling the On-board Tank

1. Close the tank to pump valve (**Figure 2**).
2. Close the tank fill valve.
3. Close the clear water discharge valve.
4. Connect a hose from the source to the suction intake.
5. Start the engine. Refer to: **"Starting and Stopping the Engine" on page 32**.
6. Press and hold the prime pump button until water fills the fire pump and adequate pressure builds up.
7. Open tank fill valve.

Priming the Foam Pump

1. Locate the inject/bypass valve on the foam pump (**Figure 18**).

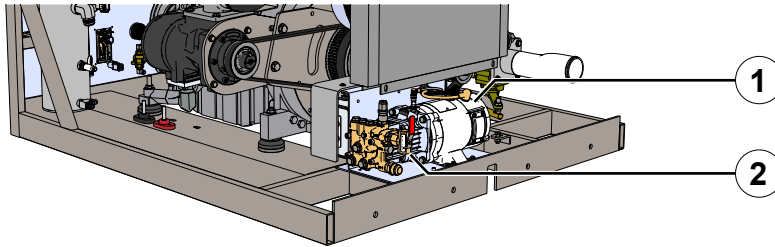

1. Foam pump

2. Inject/discharge valve

Figure 18

2. Rotate the inject/bypass handle to the bypass position. Refer the *AQUIS™ Foam System* manual.
3. Prepare a container to collect the concentrate discharged from the hose.
4. Navigate the solution screen (**Figure 8**).
5. Press the foam button to enable the foam pump (**Figure 8**).
6. Press the prime button (**Figure 8**).
7. The pump is primed when the concentrate discharges from the hose.
8. Press the prime button to stop the foam pump (**Figure 8**).
9. Rotate the inject/bypass handle to the inject position and store the hose.

Preparing for Operation

1. Check the compressor oil level. Refer to: "**Checking the Sump Oil Level**" on page 38.

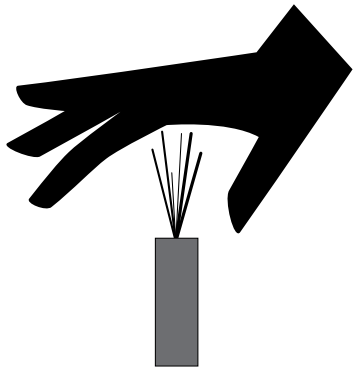
 WARNING	
<p style="font-size: 1.5em; font-weight: bold; margin: 0;">High Pressure</p> <ul style="list-style-type: none"> • Liquid ejected at high pressure can cause serious injury. • Drain the pump after use and before servicing. 	

2. Relieve pressure in the lines. Refer to: "**Relieving Waterline Pressure**" on page 37 and "**Relieving Airline Pressure**" on page 37.
3. Connect the hose to the discharge outlet (**Figure 2**).

Operating the CAFS

The CAFS has a variety of adjustments that determine the output, foam characteristics, and other operation parameters. Use the following instructions to operate and adjust the system.

Launching the Interface

Touch the press to start on the screen once the software initiates.

Operating the Discharge

1. Press the discharge button to enable the discharge (**Figure 7**).
2. Press the output button to select the output and activate the discharge.
3. Press the active button to deactivate the discharge.
4. Press the discharge button to deactivate an enabled discharge.

Adjusting the Solution Percent

1. Press on solution to navigate to the solution screen (**Figure 7**).
2. Press the plus (+) or minus (–) button to make the adjustment.

Adjusting the Valve Controls

Note: You cannot adjust the valve controls when CAFS is active.

1. Press on solution to navigate to the solution screen (**Figure 7**).
2. Press on valve controls tab to open the valve control screen (**Figure 9**).
3. Select the discharge.
4. Press the plus (+) or minus (–) button to make the adjustment.

Adjusting the Engine Speed

1. Navigate to the engine screen (**Figure 10**).
2. Press the throttle button.
3. Press the plus (+) or minus (–) button to make the adjustment.

Adjusting the Water Pressure

1. Navigate to the engine screen (**Figure 10**).
2. Press the pressure button.
3. Press the plus (+) or minus (–) button to make the adjustment.

Using Discharge 1

1. Connect a hose to discharge 1 outlet (**Figure 2**).
2. Navigate to the CAFS screen on the HMI (**Figure 7**).
3. Press the discharge button to enable the discharge.
4. Press the output button to select the output type and activate the discharge.

Using the Clearwater Discharge

1. Connect a hose to the clear water outlet on the operator panel (**Figure 2**).
2. Open the clear water discharge valve. Refer to: "**Opening the Valve**" on **page 32**.

Using the Auxiliary Air Outlet

1. Rotate the auxiliary air knob counterclockwise to open the valve (**Figure 2**).
2. Rotate the knob clockwise to close the valve.

Flushing the System

1. Prepare the hose or hoses for the flush process.
2. Press the flush button on the HMI 2 times to initiate the process (**Figure 7**).
3. If available, operate the discharge in air only mode to dry out the lines and hoses.

Operating the Drain Valve

Use the drain valves to remove the remaining liquids after flushing the system.

1. Rotate the drain valve knob counterclockwise to open the valve (**Figure 2**).
2. Rotate the knob clockwise to close the valve.
3. Make sure that you close the valve completely before operating the system.

Accessing the Interior Components

Note: The outer panels are optional equipments and not used in every application. Use the following instructions if your application is equipment with outer panels.

Opening the Top Panel

1. Locate the latches on the top panel (**Figure 3**).
2. Pull up on the latches to unlock the panel from the frame.
3. Lift the panel up.

Closing the Top Panel

1. Push down on the panel (**Figure 3**).
2. Push down on the latches to lock the panel from the frame.

Removing the Side Panel

1. Remove the screws that secure the panel to the frame and set them aside (**Figure 3**).
2. Remove the panel and set it aside.

Installing the Side Panel

1. Align the screw holes in the pane to the holes on the frame (**Figure 3**).
2. Use the screws that you set aside to secure the panel to the frame.

Typical Operation Sequence

Note: Make sure that you have sufficient fuel, concentrate, water, and oil in the system before operation.

Operating the Module

1. Open and close all drains to relieve pressure in the system. Refer to **"Operating the Drain Valve" on page 34**.
2. Connect the discharge hoses.
3. Start the engine. Refer to: **"Starting and Stopping the Engine" on page 32**.
4. Initiate the HMI. Refer to: **"Launching the Interface" on page 34**.
5. Prime the pump if you are sourcing the water externally. Refer to: **"Priming the Water Pump" on page 32**.
6. Activate the desired discharge. Refer to: **"Operating the Discharge" on page 34**.

After Operating the Module

1. Flush the discharges after operation. Refer to: **"Flushing the System" on page 34**.
2. Drain the lines. Refer to: **"Operating the Drain Valve" on page 34**.

Maintenance Precautions

Do not service this equipment if you are not familiar with the tools and skills needed to safely perform required procedures—proper maintenance is the responsibility of the purchaser. This document is not all inclusive to your system. Locate, read, understand, and follow all the instructions for the components that make up your system. Contact Waterous with question.

Do the following before you begin servicing the equipment:

- Park the apparatus on a level surface.
- Allow the equipment to cool if it was recently operated.
- Disconnect the power supply to prevent accidental operation.
- Relieve waterline pressure before servicing.
- Relieve airline pressure before servicing.
- Clean up fluid spills and debris.

NOTICE

Maintenance

- **Not following maintenance procedures can damage your equipment.**
- **Perform all maintenance procedures as required.**

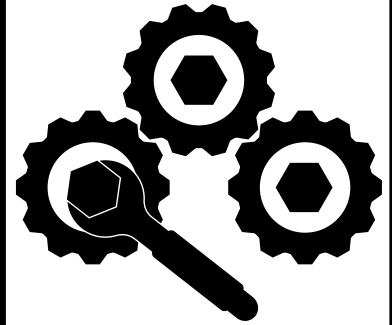

Preform all maintenance procedures as required. Not performing maintenance procedures damages equipment and voids your warranty

Maintenance Schedule

Perform the following procedures at the recommended intervals.

Operation	Interval
Check compressor the oil level	Before operation and 10 minutes after operation—add oil if necessary.
Checking the compressor oil	After the first 30 hours, then every year
Checking the compressor oil filter	With each compressor oil change.
Checking the foam pump oil	After the first 50 hours, then every 500 hours.
Checking the compressor air filter	Replace the air filter every year. (Replace more frequently if the operating conditions are dusty.)
Checking the air separator	Replace the oil separator cartridge every 2 years or if the oil consumption suddenly increases.
Maintaining the engine	Refer to the engine <i>Operator's Manual</i> .
Maintaining the compressor	Refer to the compressor <i>Operator's Manual</i> .
Maintaining the foam pump	Refer to the foam pump <i>Operator's Manual</i> .

! WARNING

High Pressure

- Liquid ejected at high pressure can cause serious injury.
- Do not operate beyond recommended pressure.

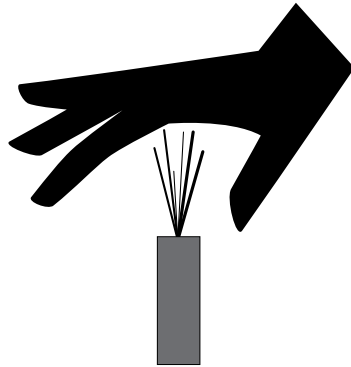

Do not operate while all discharges or drains are closed. High pressure will result and damage to foam system, its components or leaks may occur.

Relieving Waterline Pressure

Open and close the pump drain valve to relieve pressure in the water line (**Figure 2**).

Relieving Airline Pressure

The airline will bleed off over time. Open the auxiliary air outlet to vent the compressed air or pull the pop off valve to immediately relieve pressure (**Figure 19**).

! WARNING

Hot Surface

- Hot surface can burn you.
- Do not touch the surface during operation—allow it to cool after operating.

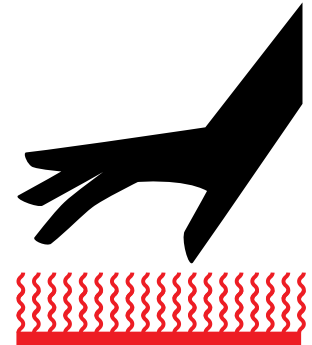

Do not service the equipment directly after operation. Allow the equipment to cool before servicing.

Servicing the Sump

Oil from the sump cools and lubricates the compressor system. Regular maintenance is necessary for efficient operation and to prevent premature failure. Use only ISO AW68 or equivalent anti wear, low/anti foaming hydraulic oil.

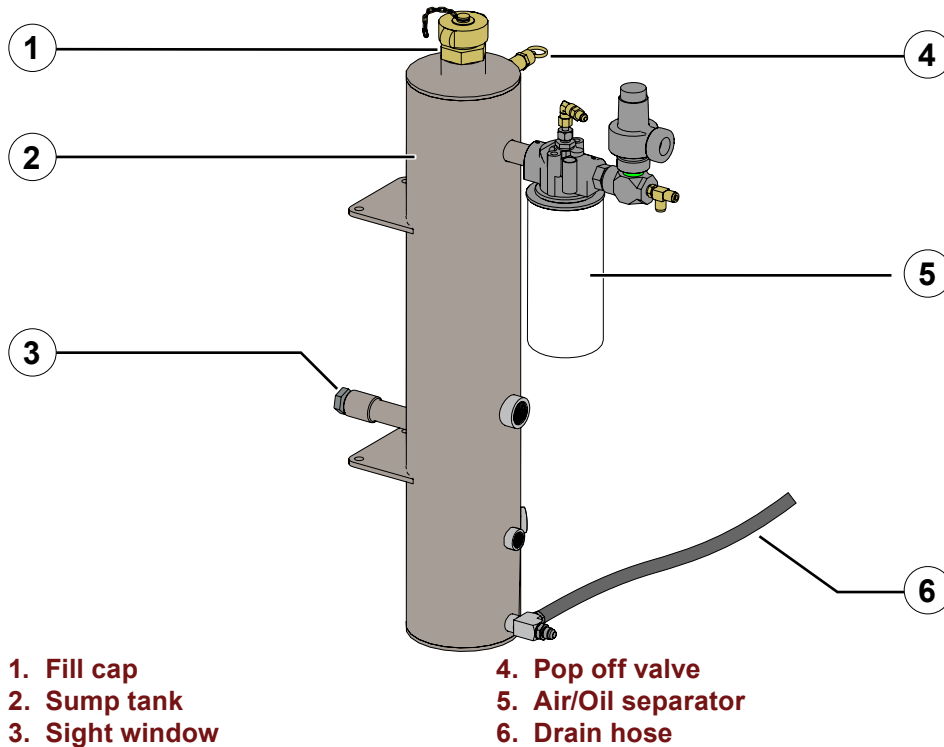

Figure 19

Checking the Sump Oil Level

1. Use the window on the operator panel to determine the compressor oil level (Figure 2).
2. Make sure that the oil is in the middle of the window.

Draining the Sump Oil

1. Relieve airline pressure before servicing. Refer to: "**Relieving Airline Pressure**" on page 37.
2. Locate the sump drain hose (Figure 19).
3. Direct the hose into a container large enough to collect all the oil.
4. Open the valve to drain the oil.
5. Store the drain hose.

Adding Sump Oil

1. Relieve airline pressure before servicing. Refer to: "**Relieving Airline Pressure**" on page 37.
2. Locate and remove the oil fill cap on the fill tube (Figure 2).
3. Add oil until it reaches the middle of the oil level window (Figure 2).
4. Run the engine for 10 seconds to flow the oil into the compressor and cooler.
5. Check the oil level and repeat step 3 and 4 until the oil is level with the middle of the sight window.
6. Install the oil fill cap and tighten it firmly.
7. Cleanup any spilled oil.

Replacing the Oil Separator

1. Relieve airline pressure before servicing. Refer to: "**Relieving Airline Pressure**" on page 37.
2. Locate and remove the used oil separator filter.
3. Prepare the replacement filter by applying sump oil to the surface of the rubber gasket.
4. Install the replacement filter.
5. Operate the air compressor to circulate oil into the filter.
6. Check the oil level and add oil if necessary.
7. Cleanup any spilled oil.

Replacing the Oil Filter

1. Relieve airline pressure before servicing. Refer to: **"Relieving Airline Pressure"** on page 37.
2. Locate and remove the used oil filter (**Figure 20**).

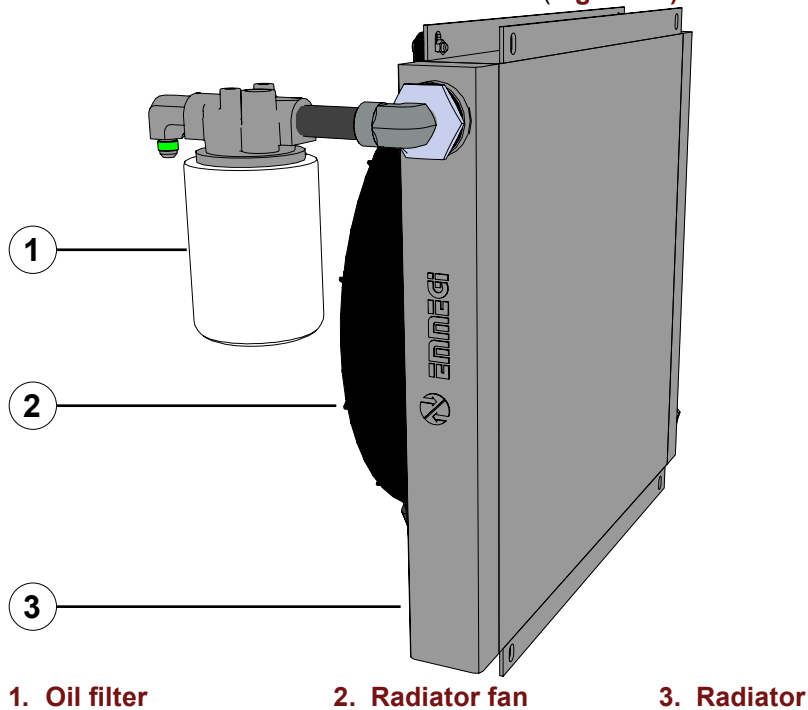
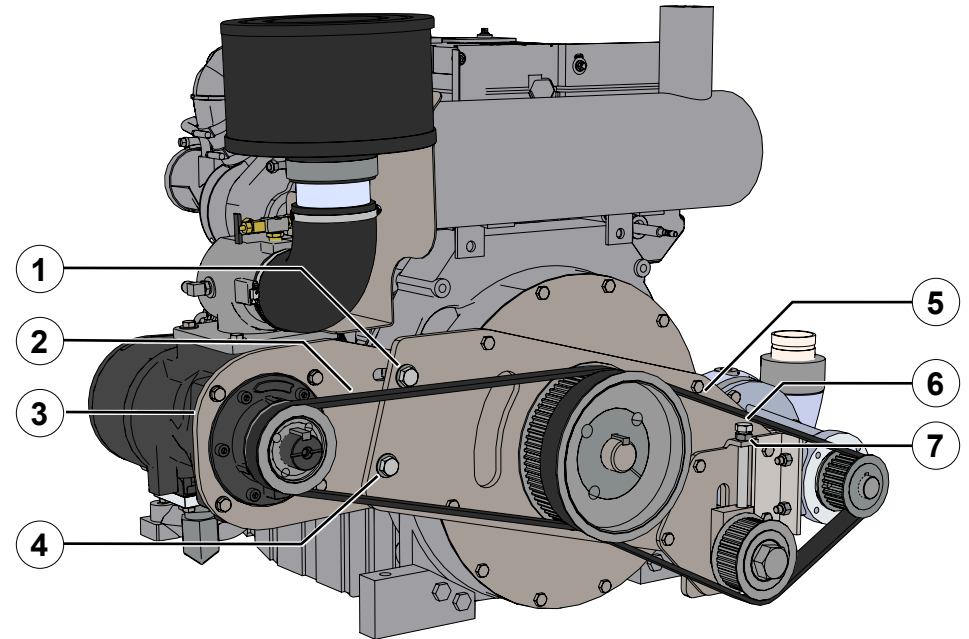

Figure 20

3. Prepare the replacement filter by applying sump oil to the surface of the rubber gasket.
4. Install the replacement filter.
5. Operate the air compressor to circulate oil into the filter.
6. Check the oil level and add oil if necessary refer to: **"Adding Sump Oil"** on page 38.
7. Cleanup any spilled oil.

Servicing the Compressor/Pump Drive Belt

1. Locate and loosen the jam nut on the slide block bolt (**Figure 21**).



- | | | |
|-----------------------|---------------------|------------|
| 1. Tension hardware | 4. Pivot hardware | 7. Jam nut |
| 2. Compressor belt | 5. Pump belt | |
| 3. Belt tension plate | 6. Slide block bolt | |

Figure 21

2. Turn the slide block bolt to loosen the belt tension enough to remove the pump belt.
3. Loosen the hardware that secures the compressor belt tension plate (**Figure 21**).
4. Loosen the tension and remove the belt.
5. Install the replacement belt.
6. Set the belt tension to 70-80 lb (32-36 kg).
7. Tighten the hardware to secure the compressor belt tension plate.

Replacing the Compressor Air Filter

Replace the air filter every year. (Replace it more frequently if the operating conditions are dusty.)

1. Open the top cover to access the air filter. Refer to: **"Accessing the Interior Components"** on page 35
2. Loosen the clamp tension nut that secures the air filter to the intake tube (**Figure 22**).

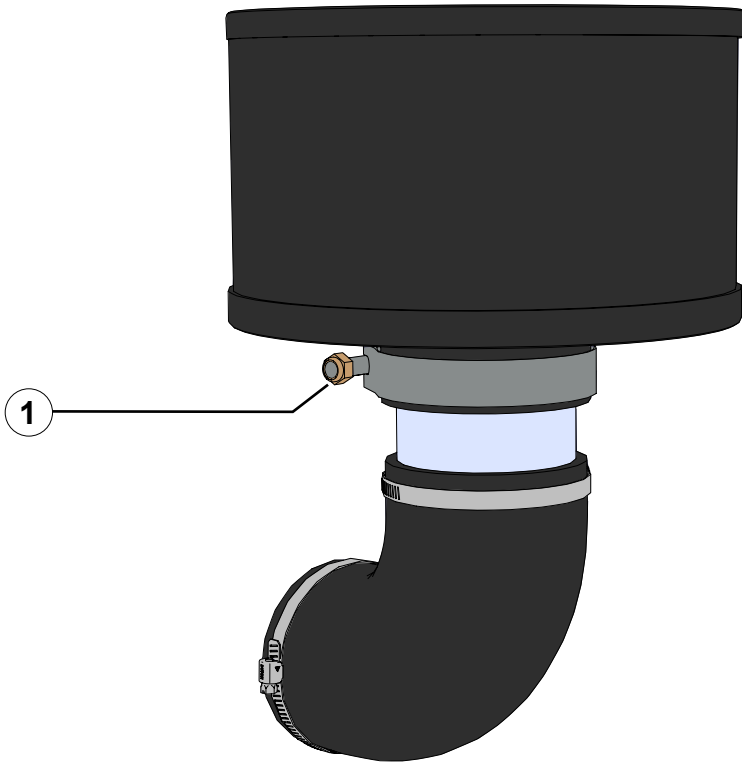

1. Clamp tension nut

Figure 22

3. Remove the used filter and install the replacement filter.
4. Tighten the screw to secure filter to the intake tube.

Servicing the Foam Pump Oil

Check the oil level after every 8 hours of use. Change the oil after the first 50 hours of operation and then every 500 hours thereafter. Refer to the foam pump *Operator's Manual*.

Servicing the Engine Oil

Refer to the engine *Operator's Manual*.

Schematic

Basic CAFS Schematic

Eclipse GEN 2.0 CAFS

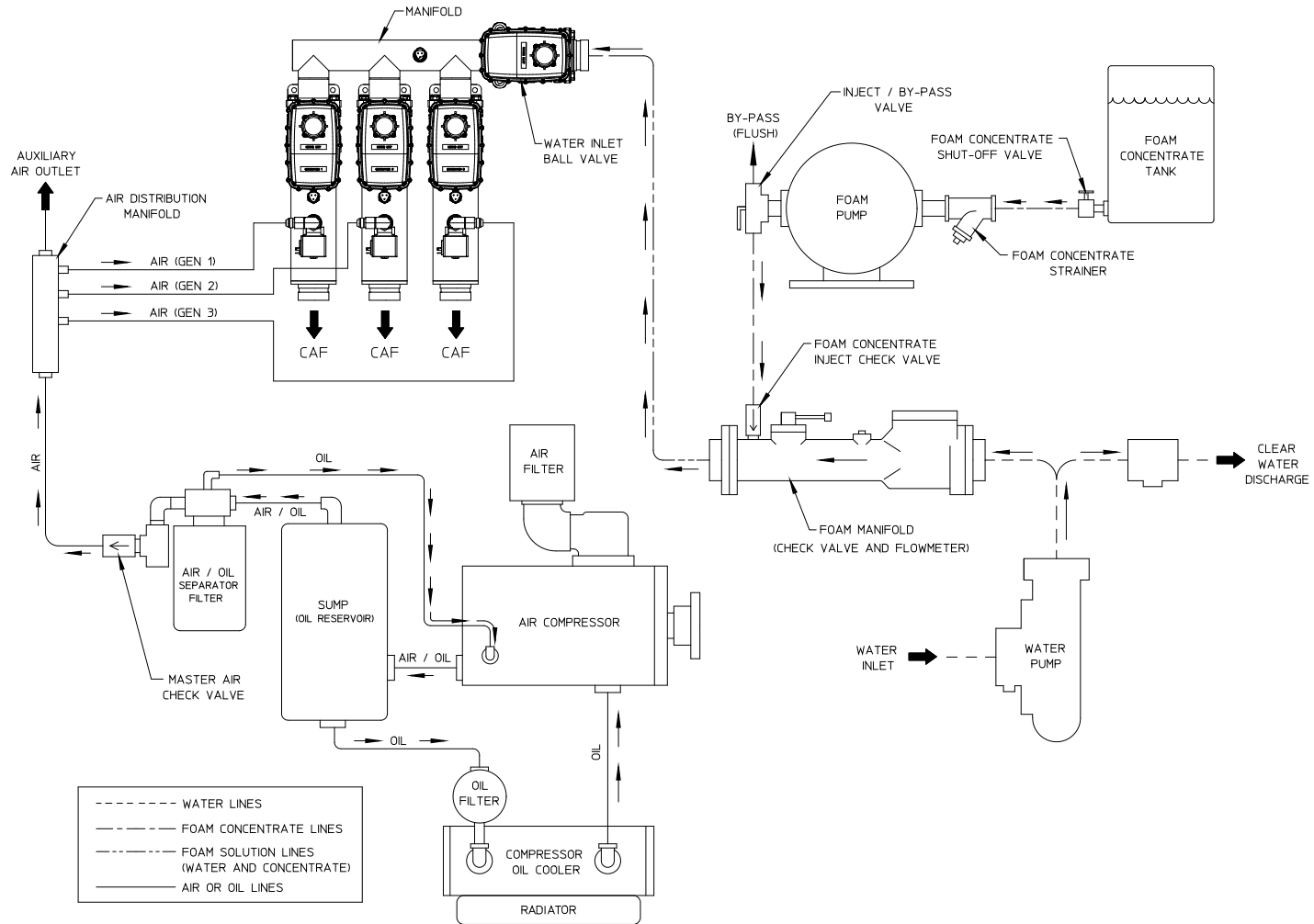

BASIC CAFS SCHEMATIC
ECLIPSE GEN 2.0 CAFS

Trouble Shooting Chart

Symptom	Possible Cause	Corrective Action
System overheating	<ul style="list-style-type: none"> • Low compressor oil level • Temperature sending unit and/or gauge circuit malfunction • Inadequate ventilation 	<ul style="list-style-type: none"> • Check oil level—adjust the oil level to the middle of the sight window • Check the hydraulic lines for kinks, change oil filters • Check wire connections at sending unit • Provide adequate ventilation • Make sure nothing is obstructing cooling or venting channels.
High oil consumption	<ul style="list-style-type: none"> • Overfull compressor oil • Running in excess of 150 CFM air flow • Air/Oil Separator Filter damaged (could be caused by air flow of higher than 150 CFM) 	<ul style="list-style-type: none"> • Adjust the oil level to the middle of the sight window • Lower the engine speed and flow CAFS to relieve pressure, then recheck • Replace air/oil separator filter • System being operated at higher than capacity
Engine stalls upon compressor engagement	<ul style="list-style-type: none"> • Engaging compressor while under load • Running system without flowing air causes oil to accumulate in compressor acting like hydraulic pump • Underrated engine horsepower • High oil level • Compressor locked up 	<ul style="list-style-type: none"> • Allow compressor to bleed down before re-engagement • Bleed down air, restart compressor, and move air • Raise the engine speed • Check oil level, adjust the oil level to the middle of the sight window. • Repair/replace compressor
Compressor locked up	<ul style="list-style-type: none"> • High oil level (compressor is flooded) • Sump fire • Low oil level or no oil 	<ul style="list-style-type: none"> • Check oil level, adjust level to half of the sight glass with vehicle parked on a level surface • Check system and repair • Check system and repair

Symptom	Possible Cause	Corrective Action
Poor CAFS (wet or dry) or no CAFS (assuming air pressure to generator is OK)	<ul style="list-style-type: none"> Using wetting agent and not foam concentrate Foam proportioning rate turned too low Foam proportioning control OFF or turned too low, foam tank empty Discharge hose not matched to generator setting 	<ul style="list-style-type: none"> Use foam concentrate Increase amount of concentrate delivered to manufacturer recommended amount Make sure proportioner is turned on and proper rate setting on Tellurus screen, foam supply valve is open, foam tank has concentrate, wye strainer is clean, and supply line is connected to injector Verify generator air injector and generator valve percentage settings. Hose size used must match generator settings. If generator is set up for 1-1/2 inch hose and a 2-1/2 inch hose is used, poor CAFS will result
Discharge hose shaking (slug flow)	<ul style="list-style-type: none"> Using wetting agent and not foam concentrate Foam proportioning rate turned too low Foam proportioning control OFF or turned too low, foam tank empty 	<ul style="list-style-type: none"> Use foam concentrate Increase amount of concentrate delivered to manufacturer recommended amount Make sure proportioner is turned on and proper rate setting on Tellurus screen, foam supply valve is open, foam tank has concentrate, wye strainer is clean, and supply line is connected to injector
Foam in the water system (when proportioner turned off)	<ul style="list-style-type: none"> Foam concentrate was poured into the on-board water tank Foam manifold drain lines not isolated from water drain lines Cooler line plumbed from manifold Foam manifold check valve defective 	<ul style="list-style-type: none"> Flush tank and pump with clean water, refill Isolate to separate drain valve Relocate line to discharge side of pump Rebuild/replace check valves
Safety pop off valve opening at low pressure	<ul style="list-style-type: none"> Sump fire damaged pop off valve 	<ul style="list-style-type: none"> Check system for other damage and replace valve
Safety pop off valve repeatedly opening	<ul style="list-style-type: none"> Trim valve or inlet completely open 	<ul style="list-style-type: none"> Trim valve should be set 3 turns open from closed position.

Contact Waterous for more information. **Waterous Company**
125 Hardman Avenue South
South St. Paul, MN 55075 USA
www.waterousco.com
(651) 450-5000