



Date Originated: 08/16/04

Revision: D

Revision Date: 04/10/06

Standards No.

Subject: For Installing and Calibrating SL 10-LED Level Monitors

Note:

This calibration procedure must be performed to ensure that the indicated fluid levels on the display accurately match the actual levels in the tank. The tank can be full or empty to begin calibration, but must be filled before beginning Step 4. To ensure proper calibration, do not have water in the fill tower.

Step 1: Install Tank Sender Unit

To ensure proper drainage, it is highly recommended that the sender unit is mounted vertically on the side of the tank by using a 90 degree 1/4" NPT fitting. Connect sender unit to the display and the display to a 12 or 24 volt power source. Go to Step 2.

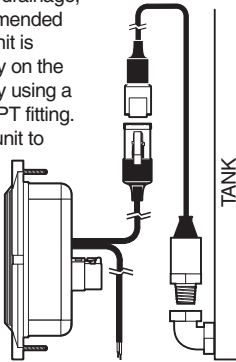

Step 2: Initiate Calibration

Within 1 min. of powering up the unit, place the magnet over the master display between the 1/2 and 3/4 levels.

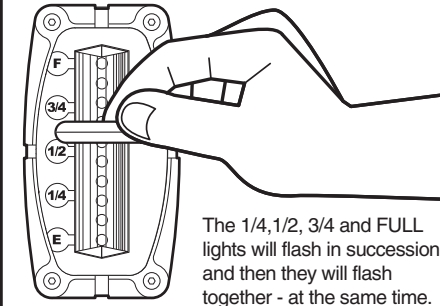

The 1/4, 1/2, 3/4 and FULL lights will flash in succession and then they will flash together - at the same time.

Step 3: Calibrating The Probe

With the 1/4, 1/2, 3/4 and FULL lights all flashing, fill tank - if not yet full. For a level-by-level calibration, do not fill tank and go to alt. instructions on page 2.

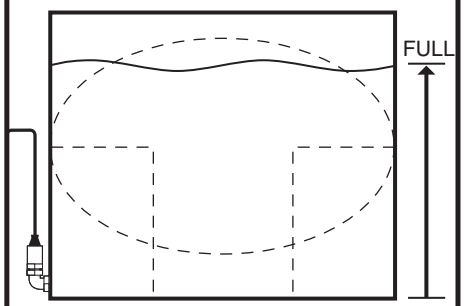

Step 4: Tank Selection Mode

Place the magnet over the display between 1/2 and 3/4 levels. The level lights will flash in sequence upward beginning the tank selection mode.

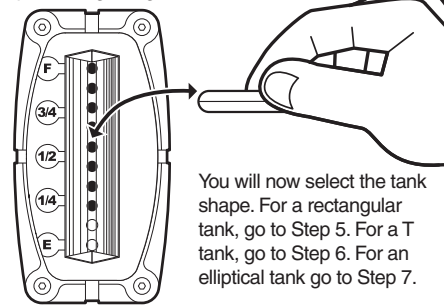

You will now select the tank shape. For a rectangular tank, go to Step 5. For a T tank, go to Step 6. For an elliptical tank go to Step 7.

Step 5: Rectangular Tank

When the 1/4 level lights begin to flash, place the magnet back onto the master display before the lights flash for the fifth time.

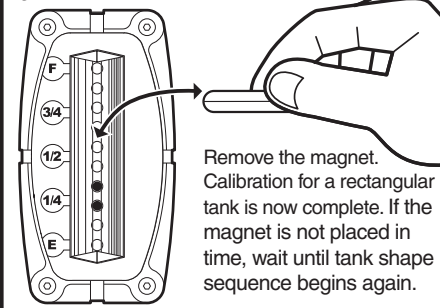

Remove the magnet. Calibration for a rectangular tank is now complete. If the magnet is not placed in time, wait until tank shape sequence begins again.

Step 6: T-Shaped Tank

When the 1/2 level lights begin to flash, place the magnet back onto the master display before the lights flash for the fifth time.

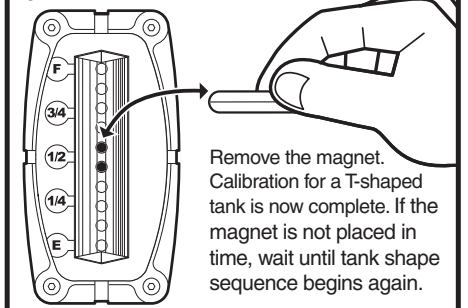

Remove the magnet. Calibration for a T-shaped tank is now complete. If the magnet is not placed in time, wait until tank shape sequence begins again.

Step 7: Elliptical Tank

When the 3/4 level lights begin to flash, place the magnet back onto the master display before the lights flash for the fifth time.

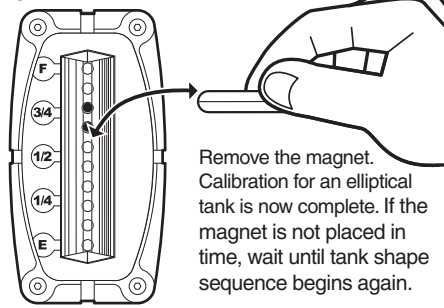

Remove the magnet. Calibration for an elliptical tank is now complete. If the magnet is not placed in time, wait until tank shape sequence begins again.

Notes:

If the magnet is not placed in front of the display to select a tank shape, the tank selection sequence will continue and the FULL light will flash 5 times. After the FULL light flashes 5 times the tank shape selection sequence will begin again. (Step 5) The tank shape selection sequence will repeat 3 times. If no tank shape selection is made in this time, the display will default to a rectangular tank.

If the display was calibrated incorrectly, remove power from the display and repeat the process. Recalibration can not occur without cycling power.



SL Series Level Monitor Calibration (Alternative)

Date Originated: 08/16/04

Revision: D

Revision Date: 04/10/06

Standards No.

Subject: For Manually Calibrating SL 10-LED Level Monitor to Unique Tank Styles and Capacities

Note:

If none of the 3 calibration modes described on the previous page is acceptable, use this special calibration mode to set each of the water or foam levels independently. **Perform Steps 1, 2, and 3 on previous page before starting Alt. Step 4.**

Alt. Step 4

With the tank empty and the 1/4, 1/2, 3/4 and FULL lights flashing, place the magnet over the master display between the 1/2 and 3/4 levels.

The 1/4, 1/2, 3/4, and FULL lights will flash in succession, bottom-up.

Alt. Step 5

Wait until the FULL level is flashing and place the magnet over the display.

The 1/4 and EMPTY lights will alternate flashing.

Alt. Step 6

Fill the tank to the desired 25% level. Check level visually or by measuring depth.

25%

Alt. Step 7

Place the magnet over the display. The 1/4 lights will stay on while the 1/2 lights begin to flash.

Alt. Step 8

Fill the tank to the desired 50% level. Check level visually or by measuring depth.

50%

Alt. Step 9

Place the magnet over the display. The 1/4 and 1/2 lights will be on while the 3/4 lights begin to flash.

Alt. Step 10

Fill the tank to the desired 75% level. Check level visually or by measuring depth.

75%

Alt. Step 11

Place the magnet over the display. The 1/4, 1/2 and 3/4 lights will be on while the FULL lights begin to flash.

Alt. Step 12

Fill the tank to the desired FULL level.

100%

Alt. Step 13

Place the magnet over the display to complete the alternate calibration process.

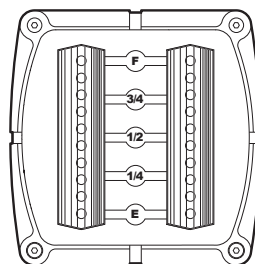

Notes:

Dual level monitors must be calibrated one side (tank) at a time for both standard calibration (front of page) and alternate calibration (above).

Both calibration methods will work for all styles of SL level monitor master displays (10 and 14 LED water and foam, mini masters, and dual displays)



Date Originated: 10/5/04	Revision: D	Revision Date: 04/10/06	Standards No.
---------------------------------	--------------------	--------------------------------	----------------------

Subject: For Installing Single and Dual SL 10-LED Tank Level Monitor Displays

Step 1: Layout Panel Cut-Outs

Use the dimensions below (can also be used as templates), layout the location(s) for the display(s). Allow enough clearance between displays and other components. Note overall display dimensions.

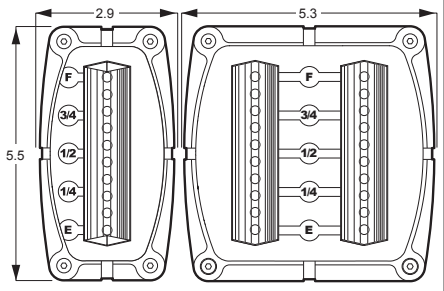

Step 2: Install Display

Feed cables through panel cut-out and secure display using the hardware provided. (Qty. 4 1/2" long 8-32 flathead SCS, and nylon insert locking nuts) Weld nuts or press-in nuts are also acceptable for panel-mounting.

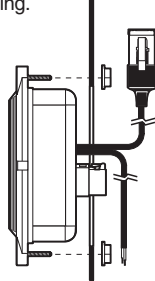

Step 3: Connect Display

Connect the display to the sender unit and a 12 or 24 volt power source.

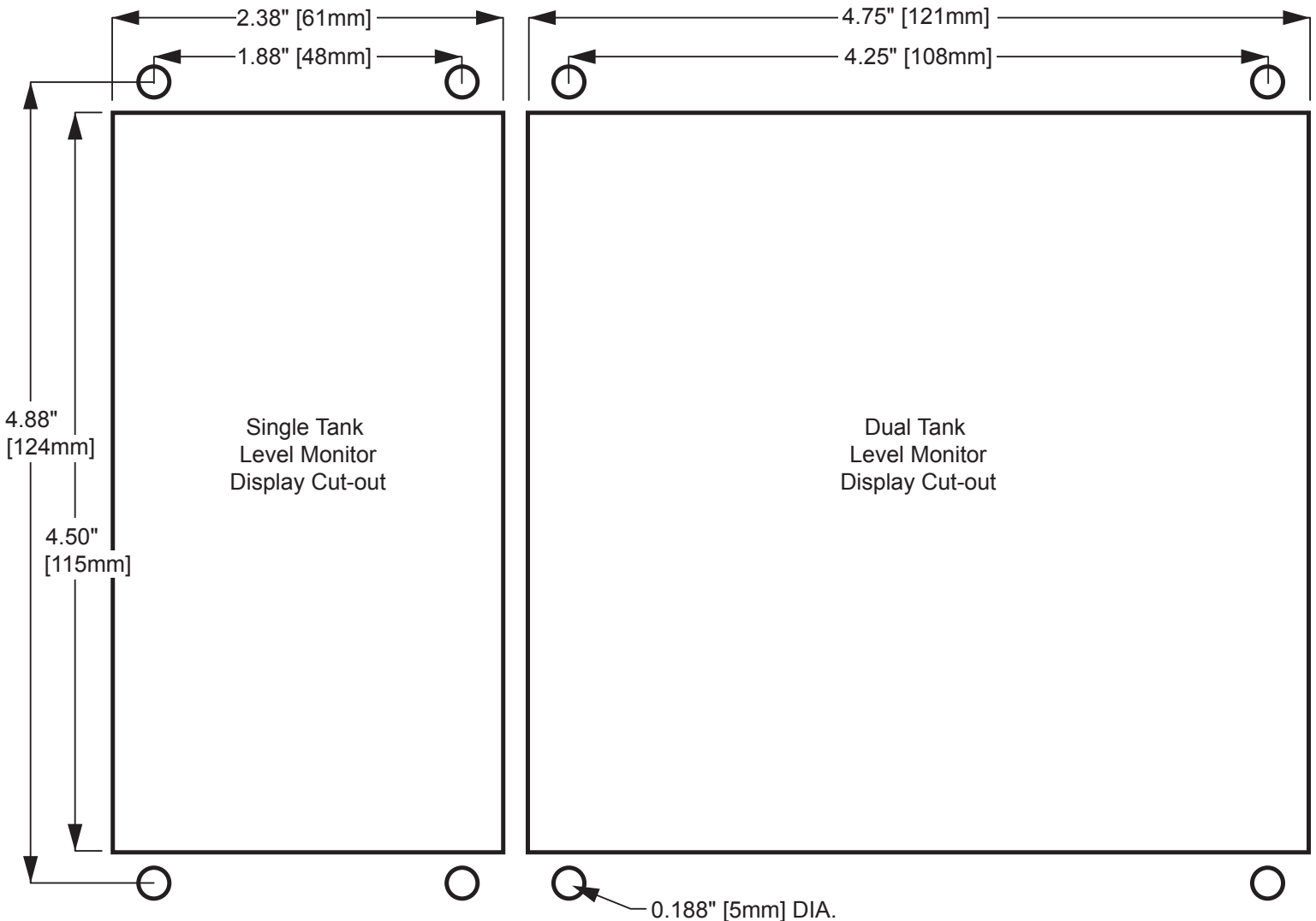
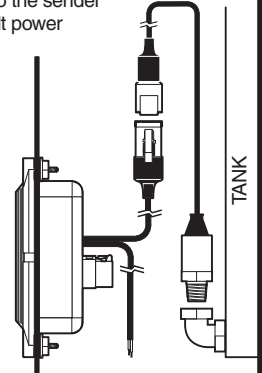



SL Series Tank Sender Installation Instructions

Date Originated: 12/05/06

Revision: B

Revision Date: 12/16/06

Standards No.

Subject: For Installing SL Series Tank Level Sender Unit

The SL Level Monitor is a pressure transducer system that converts pressure (psi) into voltage. The 5.0 VDC sensor outputs 0.25-0.31 VDC at no pressure up to a max of 4.5 VDC at 69" of water.

Step 1: Install Fitting in Tank

Install an elbow of your choice into side of the tank that will accept the 1/4" NPT thread of the sender unit as shown. The elbow should be installed at a height that will place the diaphragm inside the sender at between 1.5" and 2" from the bottom of the tank.

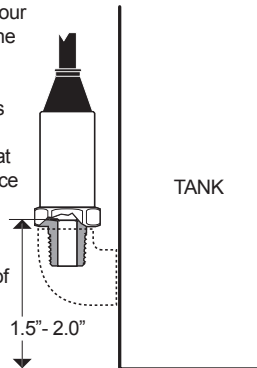

Step 2: Install Sender

Screw the sender unit into 1/4" NPT street elbow using teflon tape. Be careful to not allow the tape into the sensor bore. This will affect operation. Do not insert anything into the sensor bore. The internal diaphragm may be damaged.

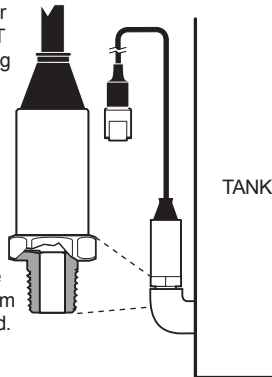

Step 3: Check Sender Seal

This step is optional. You may choose to test the seal of the sensor by partially filling the tank and inspecting the fittings for leaks.

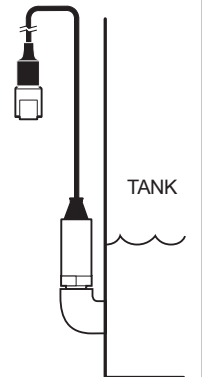

Step 4: Connect Sender Unit

Connect the sender unit to the master display via an extension cable.

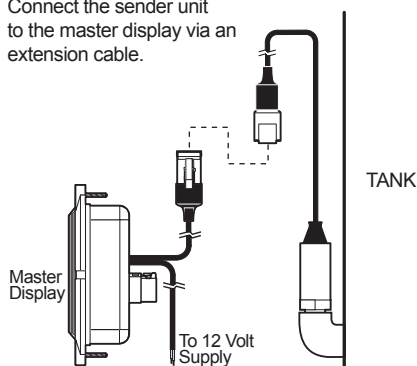

See SL Calibration Instructions to calibrate sender unit.